

TOWN OF CARY NORTH CAROLINA

FY20-21 SEWER REHABILITATION PROJECT

PROJECT NO. SW3501

MARCH 2021

INDEX OF SHEETS

G-1	GENERAL NOTES
C-1	BLACK CREEK 24" AND 30" INTERCEPTOR
C-2	BLACK CREEK 24" AND 30" INTERCEPTOR
C-3	CRABTREE CREEK INTERCEPTOR
C-4	CRABTREE CREEK INTERCEPTOR
C-5	BLACK CREEK 54" INTERCEPTOR
C-6	REPAIR AT MH-SP76518076
C-7	GREENWAY COORDINATION REQUIREMENTS
D-1	DETAILS
D-2	DETAILS
D-3	DETAILS
D-4	DETAILS
D-5	DETAILS

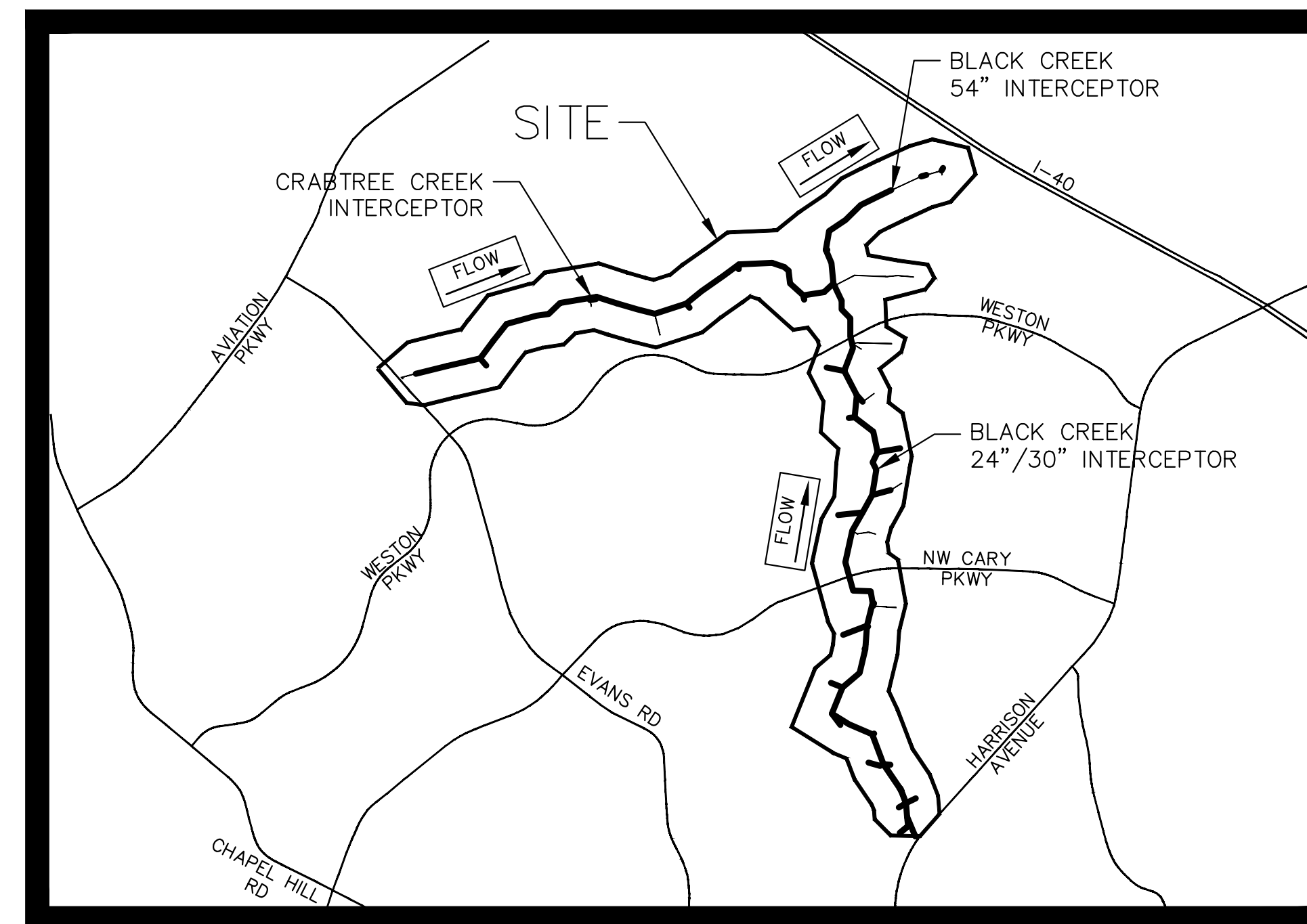

VICINITY MAP
1" = 2,000'

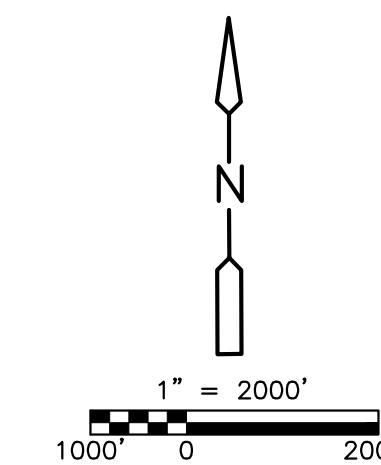

Frazier Engineering, P.A.
 6592 Bob White Trail
 Stanley, NC 28164
 Office 704.822.8444
 Fax 704.822.8666

GENERAL NOTES

1. GENERAL PROJECT INFORMATION:

THE SEWERS, MANHOLES AND OTHER FEATURES SHOWN ON THE DRAWINGS ARE TO BE CONSIDERED APPROXIMATE LOCATIONS AND ARE FOR GENERAL INFORMATION ONLY. THE DRAWINGS DO NOT SHOW ALL OF THE HOMES AND BUSINESSES IN THE AREA OR OTHER EXISTING UTILITIES- THE CONTRACTOR IS ADVISED THAT THE AREA IS CONGESTED WITH HOMES, BUSINESSES AND UTILITIES. IN ADDITION, ALL CURRENT ROADS AND CONNECTING SEWERS MAY NOT BE SHOWN. THE CONTRACTOR SHALL MAKE NECESSARY SITE INVESTIGATIONS TO DETERMINE ACTUAL LOCATIONS PRIOR TO BIDDING. THE DRAWINGS ARE BASED ON THE OWNER'S GEOGRAPHIC INFORMATION SYSTEM (GIS). CERTAIN AREAS ON THE DRAWINGS ARE CONGESTED WITH EXISTING MANHOLES AND SEWERS. THE ENGINEER WILL ASSIST THE CONTRACTOR WITH GIS MAPS OF INDIVIDUAL AREAS AS REQUESTED.

THE SEWERS IN THIS PROJECT ARE OLD AND IN POOR CONDITION. THE CONTRACTOR SHOULD EXPECT DISCREPANCIES BETWEEN THE DRAWINGS AND THE ACTUAL SEWER CONFIGURATIONS AND LOCATIONS. THESE DISCREPANCIES WILL BE FOUND THROUGHOUT THE WORK AND SHALL BE COORDINATED/ADDRESSED IN THE FIELD WITH THE ENGINEER/OWNER AND SHALL BE DOCUMENTED ON THE RECORD DRAWINGS. THE CONTRACTOR SHALL MAKE FIELD INVESTIGATIONS AND/OR ASSUMPTIONS FOR THE UNAVAILABLE INFORMATION AS DEEMED NECESSARY WHEN DEVELOPING A BID.

THIS CONTRACT WILL BE USED TO REHABILITATE EXISTING SANITARY SEWERS AND MANHOLES THROUGHOUT THE OWNER'S SERVICE AREAS AS SHOWN ON THE PLAN SHEETS. THE WORK UNDER THIS CONTRACT INCLUDES CLEANING AND TELEVISION EXISTING SEWERS, PERFORMING SEWER REPAIRS/REPLACEMENTS, INSTALLING CIPP, AND REHABILITATING MANHOLES.

THE EXISTING SEWER INFORMATION AND REHABILITATION REQUIREMENTS SHOWN IN THE TABLES ARE BASED ON CLOSED CIRCUIT TELEVISION (CCTV) INSPECTION AND INFORMATION OBTAINED BY THE OWNER OVER THE LAST 2 TO 5 YEARS. THE EXISTING CCTV VIDEO WILL BE MADE AVAILABLE TO PROSPECTIVE BIDDERS BY CONTACTING MARK LAMBERT AT MLAMBERT@FRAZIER-ENGINEERING.COM. IN SOME INSTANCES, INFORMATION ON EXISTING SEWERS/MANHOLES IS NOT AVAILABLE. IN PARTICULAR THE "CONNECTOR SEWERS" AS SHOWN IN THE TABLES ON SHEETS C-1 THROUGH C-5. THE "CONNECTOR SEWERS" WILL BE TELEVIEWED IN THIS CONTRACT TO DETERMINE THE REQUIRED REHABILITATION. IN ADDITION, THE ENGINEER WILL BE PERFORMING ADDITIONAL MANHOLE INSPECTIONS THROUGHOUT THE PROJECT AND IT IS ANTICIPATED THAT ADDITIONAL WORK WILL BE ADDED, PARTICULARLY TO THE MANHOLES LISTED AS "CONNECTOR SEWER MANHOLES" IN THE TABLES ON SHEETS C-1 THROUGH C-5.

THE CONTRACTOR SHALL BE RESPONSIBLE FOR CONFIRMING LOCATIONS AND POSITIONS OF SERVICE LATERALS. THE CONTRACTOR SHALL ALSO BE RESPONSIBLE FOR DETERMINING ACCURATE SEWER DIAMETERS.

2. SCOPE OF WORK AND PROJECT IMPLEMENTATION:

THE CONTRACTOR IS ADVISED THAT ADDITIONAL SEWERS AND MANHOLES MAY BE ADDED TO THIS CONTRACT FOR REHABILITATION TO ADDRESS ADDITIONAL SEWER OR MANHOLE PROBLEMS THAT ARE IDENTIFIED. THE ADDED SEWERS AND MANHOLES MAY BE LOCATED ANYWHERE WITHIN THE OWNER'S SERVICE AREA. THE UNIT PRICES BID SHALL INCLUDE REHABILITATING ANY ADDED SEWERS AND MANHOLES REGARDLESS OF LOCATION, QUANTITY OR LAYOUT.

3. SEWER REHABILITATION AND SEQUENCE OF CONSTRUCTION:

IT IS THE INTENT OF THIS CONTRACT TO LINE THE SEWERS IDENTIFIED IN THE TABLES WITH CURED-IN-PLACE PIPE (CIPP) UNLESS OTHERWISE NOTED. THE CONTRACTOR'S TELEVISION INSPECTIONS PERFORMED UNDER THIS CONTRACT WILL BE USED TO CONFIRM THAT THE SEWERS CAN BE LINED AND/OR TO CONFIRM PREVIOUS TELEVISION INSPECTIONS. IT IS POSSIBLE THAT SOME SEWERS CAN NOT BE LINED UNTIL POINT REPAIRS ARE PERFORMED. IT IS ALSO POSSIBLE THAT SOME OF THE SEWERS WILL NOT REQUIRE LINING.

GENERALLY, THE CONTRACTOR SHALL DETERMINE THE SCHEDULE WITHIN THE FRAMEWORK OUTLINED HEREIN. THE SEQUENCE OF CIPP INSTALLATION SHALL BE AS FOLLOWS:

- 1. CRABTREE CREEK INTERCEPTOR (SHEETS C-3 AND C-4)
- 2. BLACK CREEK 24" AND 30" INTERCEPTOR (SHEETS C-1 AND C-2)
- 3. BLACK CREEK 54" INTERCEPTOR (SHEET C-5)

ALL CIPP MUST BE INSTALLED WITHIN THE AREAS OUTLINED ABOVE BEFORE PROCEEDING TO ANOTHER AREA. AT THE CONTRACTOR'S OPTION, WORK MAY OCCUR SIMULTANEOUSLY IN THE BLACK CREEK 24" AND 30" INTERCEPTOR AND BLACK CREEK 54" INTERCEPTOR. ONLY ONE SECTION OF THE GREENWAY CAN BE CLOSED AT A TIME SO THAT ACCESS TO ALTERNATE SECTIONS OF THE GREENWAY REMAIN ACCESSIBLE TO THE PUBLIC. SECTIONS OF THE GREENWAY REFER GENERALLY TO THE BLACK CREEK 24"/30" INTERCEPTOR AREA, THE CRABTREE CREEK AREA, AND THE BLACK CREEK 54" INTERCEPTOR AREA. ALL WORK WITHIN AN AREA SHALL BE PERFORMED BEFORE REOPENING AND MOVING TO ANOTHER AREA. THIS INCLUDES ALL CIPP INSTALLATION, MANHOLE REHABILITATION, OTHER NOTED WORK WITHIN THE AREA, FINAL RESTORATION, AND ALL ELSE RELATED THERETO. AFTER REOPENING A GREENWAY AREA, NO ACCESS/WORK SHALL BE PERMITTED IN THE AREA AND NO ADDITIONAL CLOSURES WILL BE PERMITTED.

SEE SHEET C-7 FOR ADDITIONAL REQUIREMENTS PERTAINING TO THE GREENWAYS.

4. SEWER CLEANING AND CCTV INSPECTION:

THE CONTRACTOR'S UNIT PRICE FOR CLEANING AND TELEVISION THE EXISTING SEWERS SHALL INCLUDE COSTS FOR COMPLETE CLEANING, ROOT AND GREASE REMOVAL, SILT/SAND REMOVAL AND TUBERCULATION REMOVAL, REGARDLESS OF THE SEVERITY. THE CONTRACTOR IS ADVISED THAT THE OWNER WILL NOT PROVIDE A LOCATION TO DISPOSE OF DEBRIS REMOVED FROM THE SEWER.

CONTRACTOR SHALL USE EXTREME CAUTION WHEN CLEANING SEWERS TO PREVENT STRUCTURALLY DAMAGED SEWERS AND THE OLDER SEWERS FROM COLLAPSING. CONTRACTOR SHALL BE RESPONSIBLE FOR REMOVING ANY CLEANING OR TELEVISION INSPECTION EQUIPMENT TRAPPED BY COLLAPSED SEWERS. THE CONTRACTOR SHALL NOTIFY THE ENGINEER IN WRITING OF ANY CONCERNS PRIOR TO CLEANING SEWERS.

THE CONTRACTOR SHALL USE EXTREME CAUTION WHEN CLEANING SEWERS AND SHALL BE RESPONSIBLE FOR DAMAGE TO EXISTING HOMES CAUSED BY CLEANING OPERATIONS. ANY SPILLS SHALL BE CLEANED UP IMMEDIATELY. ANY DAMAGE SHALL BE REPAIRED IMMEDIATELY. THE CONTRACTOR SHALL HAVE A LOCAL CLEANING SERVICE UNDER CONTRACT PRIOR TO STARTING THE SEWER CLEANING TO CLEAN UP ANY SPILLS OR BACKUPS.

AT THE CONTRACTOR'S OPTION, SEWER CLEANING OPERATIONS MAY BEGIN UNDER FLOW PRIOR TO BY-PASS PUMPING. HOWEVER, FINAL SEWER CLEANING SHALL OCCUR AFTER BY-PASS PUMPING IS IN OPERATION.

THE OWNER WILL PERFORM REGULAR AND SPECIAL TESTING OF WASTEWATER AT ITS WATER RECLAMATION FACILITIES. SEWER CLEANING AND CIPP INSTALLATION OF PIPES GREATER THAN 8" WILL BE PROHIBITED 48 HOURS IN ADVANCE OF THE SCHEDULED SAMPLING AND UNTIL SAMPLING HAS BEEN COMPLETED IN THE IMPACTED AREAS. THIS SAMPLING OCCURS ON A QUARTERLY BASIS AND LASTS FOR APPROXIMATELY ONE WEEK. THE OWNER WILL PROVIDE AT LEAST TWO WEEKS NOTICE OF THESE TESTING LOCATIONS AND SEWER CLEANING AND CIPP INSTALLATION RESTRICTIONS.

REFER TO THE TECHNICAL SPECIFICATIONS FOR ADDITIONAL REQUIREMENTS.

5. CIPP INSTALLATION:

ALL SEWERS LISTED IN THE TABLES SHALL BE LINED WITH CIPP AS SPECIFIED UNLESS OTHERWISE NOTED OR DIRECTED OTHERWISE BY THE ENGINEER. THE CIPP SHALL BE ONE OF THE APPROVED PRODUCTS SPECIFIED.

THE BLACK CREEK 24"/30" INTERCEPTOR, THE CRABTREE CREEK INTERCEPTOR, AND THE BLACK CREEK 54" INTERCEPTOR HAVE BEEN PREVIOUSLY TELEVIEWED. THE CONTRACTOR SHALL IDENTIFY ANY POINT REPAIRS NEEDED FOR THE SEWERS THAT HAVE BEEN PREVIOUSLY TELEVIEWED OR REQUIRED POINT REPAIRS FOR SEWERS THAT HAVE NOT BEEN TELEVIEWED PRIOR TO CIPP INSTALLATION DURING THE PRE-REHAB CCTV INSPECTION AND SUBMIT RECOMMENDATIONS TO THE ENGINEER FOR REVIEW AS SPECIFIED.

CONTRACTOR SHOULD USE EXTREME CARE WHEN INSTALLING LINERS THROUGH OLD MANHOLES. ANY DAMAGE CAUSED SHALL BE PAID FOR BY THE CONTRACTOR AT NO ADDITIONAL COST TO THE OWNER. IF THE CONTRACTOR HAS TO REMOVE THE FRAME AND COVER IN ORDER TO INSTALL THE LINER, THE FRAME SHALL BE RESET IN ACCORDANCE WITH THE OWNER'S STANDARD DETAILS AND REQUIREMENTS AT NO ADDITIONAL COST TO OWNER.

LINER PIPES SHALL BE TERMINATED IN THE MANHOLES PER THE STANDARD DETAILS. THE INVERT OF EACH MANHOLE SHALL BE COATED WITH AN APPROVED GROUT TO RAISE THE INVERT ELEVATION TO MATCH THE LINED PIPES AND TO PROVIDE A SMOOTH UNIFORM FLOW CHANNEL THROUGH THE MANHOLE. A CONSTANT SLOPE SHALL BE PROVIDED FROM THE INLET TO OUTLET SEWERS. THE COST FOR COATING THE INVERT CHANNELS SHALL BE INCLUDED IN THE UNIT PRICE BID FOR THE CIPP. THE CIPP MANHOLE CONNECTION SHALL ALSO BE SEALED WITH A WATER-STOP AND NON-SHRINK GROUT AS SPECIFIED. THE ENTIRE AREA AND VOIDS BETWEEN AND AROUND THE CIPP MANHOLE CONNECTION SHALL BE COMPLETELY FILLED AND COATED WITH A NON-SHRINK GROUT TO PROVIDE A LEAK-TIGHT CONNECTION. IN SOME SITUATIONS, INJECTION GROUTING MAY BE REQUIRED TO COMPLETELY SEAL THE CONNECTION. THE COST OF THIS WORK SHALL BE INCLUDED IN THE UNIT PRICE FOR CIPP.

WHEN THE CONTRACTOR LINES MULTIPLE SEGMENTS AT ONE TIME AND WHERE SPECIFICALLY APPROVED BY THE ENGINEER/OWNER, THE CONTRACTOR SHALL LEAVE THE LINER THROUGH THE INTERMEDIATE MANHOLES TO SERVE AS THE INVERT CHANNEL. IN THESE INSTANCES, THE TOP ONE-HALF OF THE LINER SHALL BE NEATLY REMOVED, AND THE VOID BEHIND THE LINER PIPE SHALL BE INJECTED WITH AN APPROVED PUMPABLE GROUT AND THEN FURTHER FILLED AND CAPPED WITH NON-SHRINK GROUT. THE COST OF THIS WORK SHALL BE INCLUDED IN THE UNIT PRICE FOR CIPP. THE ENGINEER/OWNER MUST APPROVE EVERY LOCATION WHERE CIPP WILL REMAIN IN THE MANHOLES. THE ENGINEER/OWNER MAY ALSO REQUIRE THAT CIPP BE LEFT IN CERTAIN MANHOLES EVEN THOUGH NOT PLANNED BY THE CONTRACTOR.

ALL ACTIVE SERVICE LATERALS SHALL BE RECONNECTED TO THE CIPP VIA AN INTERNAL REMOTE CUTTER AFTER LINER INSTALLATION. OPENINGS FOR SERVICES SHALL BE 100% OF THE EXISTING LATERAL PIPE DIAMETER. THE ENTIRE SERVICE LATERAL OPENING SHALL BE SMOOTH AND FREE OF BURRS. ONLY ACTIVE SERVICES SHALL BE RECONNECTED TO THE CIPP UNLESS DIRECTED OTHERWISE BY THE ENGINEER/OWNER. THE ENGINEER/OWNER WILL ASSIST AND COORDINATE WITH THE CONTRACTOR TO DETERMINE WHICH SERVICES ARE ACTIVE.

THERE MAY BE MANHOLES THAT ARE NOT CALLED OUT IN THE TABLES THAT ARE DROP MANHOLES. EXISTING DROPS SHALL NOT BE LINED BUT SHALL BE FULLY OPENED AND BRUSHED SMOOTHLY AFTER LINER INSTALLATION. THE COST OF THE OPENING DROP CONNECTIONS SHALL BE INCLUDED IN THE UNIT PRICE BID FOR CIPP.

THE CONTRACTOR SHALL BE RESPONSIBLE FOR INSPECTING THE SEWER LINES AND MANHOLES PRIOR TO INSTALLATION OF CIPP LINERS. ANY CONCERNS THAT MAY AFFECT CIPP INSTALLATION SHALL BE PROVIDED IN WRITING TO THE ENGINEER PRIOR TO ORDERING OR INSTALLING LINERS. INSTALLATION OF CIPP LINERS SHALL CONSTITUTE ACCEPTANCE OF THE EXISTING CONDITIONS.

REFER TO THE TECHNICAL SPECIFICATIONS FOR ADDITIONAL REQUIREMENTS.

6. MANHOLE REHABILITATION:

SOME MANHOLES AS LISTED IN THE TABLES SHALL BE SPRAYED WITH A CEMENTITIOUS MATERIAL AS SPECIFIED. THE MANHOLE REHABILITATION MATERIALS AND METHODS SHALL BE AS SPECIFIED. ALL CEMENTITIOUS MATERIAL SPRAYED ON THIS PROJECT SHALL BE HYDROGEN SULFIDE RESISTANT MATERIAL.

THE CONTRACTOR SHALL CLEAN EACH MANHOLE TO BE COATED AND SHALL DISPOSE OF ANY RESULTING MATERIAL. THE CLEANING SHALL BE PERFORMED USING A HIGH POWER JET WASH AT A MINIMUM OF 3,500 PSI. THE NOZZLE OF THE POWER WASHER SHALL BE A MAXIMUM OF 4 INCHES FROM THE WALL DURING CLEANING. ALL DUST, BIOLOGICAL GROWTHS, GREASE, OIL, PAINT OR ANY OTHER SURFACE CONTAMINANTS SHALL BE REMOVED. ROOTS SHALL BE REMOVED MANUALLY BY CUTTING THE ROOTS FROM INSIDE THE MANHOLE.

THE CONTRACTOR SHALL CONDUCT A VISUAL INSPECTION OF EACH MANHOLE AFTER IT IS CLEANED. ALL ACTIVE HYDROSTATIC LEAKS SHALL BE PLUGGED OR SEALED WITH AN APPROVED GROUT COMPATIBLE WITH CEMENTITIOUS LINING. INJECTION GROUTING MAY BE REQUIRED TO SEAL ACTIVE LEAKS. CONTRACTOR SHALL SMOOTH OUT ANY ROUGH UNEVEN AREAS ON WALLS, BENCHES OR INVERTS WHERE NEEDED PRIOR TO SPRAY APPLICATION.

THE CONTRACTOR SHALL NOTIFY ALL HOMEOWNERS THAT DISCHARGE DIRECTLY TO THE MANHOLE BEING REHABILITATED 72 HOURS IN ADVANCE, GIVING THE DATE, START TIME, AND ESTIMATED COMPLETION TIME.

THE CONTRACTOR SHALL BYPASS SEWAGE FLOWS DURING THE WORK AS SPECIFIED. THE CONTRACTOR SHALL FURNISH AND PLACE CEMENTITIOUS LINING IN EACH MANHOLE AS SHOWN ON THE STANDARD DETAIL. THE CONTRACTOR SHALL BE RESPONSIBLE FOR COMPLETING ALL ADDITIONAL REQUIREMENTS.

IT IS ANTICIPATED THAT VACUUM TESTING WILL NOT BE PERFORMED ON MANHOLES WHERE BYPASS PUMPING WOULD BE REQUIRED. VACUUM TESTING WILL GENERALLY BE REQUIRED ON MANHOLES ON SMALLER DIAMETER SEWERS WHERE BYPASS PUMPING WOULD NOT BE REQUIRED AND/OR ON MANHOLES WHERE BYPASS PUMPING IS ALREADY IN PLACE. WHERE REQUIRED, VACUUM TESTING SHALL BE COMPLETE PRIOR TO PAYMENT. CUBE TESTS OF CEMENTITIOUS MORTAR SHALL BE SUBMITTED WITHIN 30 DAYS OF TAKING THE SAMPLE WITH ALL RESULTS REQUIRED PRIOR TO FINAL PAYMENT.

REFER TO THE TECHNICAL SPECIFICATIONS FOR ADDITIONAL REQUIREMENTS.

7. ACCESS TO THE PROJECT SITES:

THE CONTRACTOR SHALL BE SOLELY RESPONSIBLE FOR ACCESSING THE SEWERS AND MANHOLES TO PERFORM THE WORK, INCLUDING DETERMINING ACCESS REQUIREMENTS AND DEVELOPING ALTERNATE ACCESS POINTS AS REQUIRED, REMOVING AND REPLACING TO EQUAL CONDITIONS MOVABLE OBSTACLES (SUCH AS FENCES), NEGOTIATING WITH PROPERTY OWNERS, AND RESTORING ALL AREAS DISTURBED BY THE WORK TO EQUAL OR EXCEED PRECONSTRUCTION CONDITIONS.

WHERE ADDITIONAL GROUND STABILIZATION MAY BE REQUIRED FOR ACCESS, ONLY CONSTRUCTION MATTING IS PERMITTED FOR THE WORK SHOWN ON SHEETS C-3, C-4, AND C-5 (CRABTREE CREEK AND BLACK CREEK 54" INTERCEPTOR AREAS).

THE CONTRACTOR SHALL SUBMIT A PROPOSED PLAN FOR ACCESSING THE SEWERS AND MANHOLES AS REQUESTED BY THE ENGINEER. THE PROPOSED PLAN SHALL BE DETAILED AND SHALL DEFINE EACH ACCESS POINT. THE PLAN SHALL CLEARLY INDICATE ANY EASEMENT CLEARING, SPECIFIC TREE REMOVAL, OR OTHER SPECIAL PROVISIONS REQUIRED. THE CONTRACTOR SHALL MODIFY THE PLAN AS REQUIRED BY THE ENGINEER.

THE CONTRACTOR SHALL ALSO CLEARLY INDICATE LOCATIONS ON THE PROPOSED ACCESS PLAN WHERE CREEK CROSSINGS ARE REQUIRED. DEPENDING ON THE SITUATION, THE OWNER MAY NEED TO OBTAIN PERMIT APPROVAL FOR CREEK CROSSINGS. THEREFORE, AT LEAST 90 DAYS NOTICE IS REQUIRED FROM THE CONTRACTOR FOR CREEK CROSSINGS.

THE OWNER HAS COORDINATED WITH SELECTED PROPERTY OWNERS WHERE ACCESSING THE SITE EXCLUSIVELY FROM WITHIN THE EXISTING SEWER EASEMENT IS IMPRACTICAL. THESE PROPERTIES WILL BE SUBJECT TO SPECIFIC REVIEW AND APPROVAL OF THE CONTRACTOR'S PLAN FOR ACCESSING THE WORK BY THE ENGINEER/OWNER. IN ADDITION, THESE PROPERTIES MAY HAVE SPECIFIC REQUIREMENTS INCLUDING TIME/DATE RESTRICTIONS THAT MUST BE MET IN ORDER TO UTILIZE THE GRANTED ACCESS. THE SELECTED PROPERTY OWNERS INCLUDE THE FOLLOWING:

- SHEET C-3: WAKE COUNTY
- SHEET C-4: WAKE COUNTY, MCI WORLDCOM, NC BAR ASSOCIATION (EXPECTED)
- SHEET C-5: WAKE COUNTY, WESTON I & II (EXPECTED)

ACCESS SHALL BE ALONG THE EXISTING SEWER EASEMENTS OR WITHIN THE EXISTING ROAD RIGHT-OF-WAYS AND WORK SHALL BE MAINTAINED WITHIN THE EASEMENTS AND RIGHT-OF-WAYS UNLESS OTHERWISE APPROVED BY THE INDIVIDUAL PROPERTY OWNERS AND/OR THE ENGINEER. THE CONTRACTOR SHALL BE RESPONSIBLE FOR NEGOTIATING WITH PROPERTY OWNERS FOR SUCH ALTERNATE ACCESS AND SHALL PAY ANY AND ALL COSTS ASSOCIATED WITH SUCH ALTERNATE ACCESS AS SPECIFIED ABOVE. ALL SUCH NEGOTIATIONS WITH PROPERTY OWNERS SHALL BE IN WRITING, AND COPIES OF THE AGREEMENTS SHALL BE SUBMITTED TO THE ENGINEER PRIOR TO USING THE ACCESS.

THE COSTS FOR ACCESSING THE SEWER SHALL BE INCLUDED IN THE VARIOUS UNIT PRICES BID. THE UNIT COSTS SHALL INCLUDE ANY AND ALL ACCESS TO THE SEWER INCLUDING RESTORATION, REPAIRS, AND CLEANUP.

THERE IS A BID ITEM FOR A SPECIFIC CREEK CROSSING DETAIL THAT MAY BE APPROVED BY THE ENGINEER IF SPECIFICALLY REQUESTED BY THE CONTRACTOR. SEE THE BID FORM AND PAY ITEM DESCRIPTION SECTION FOR ADDITIONAL INFORMATION.

8. MAINTENANCE OF FLOW IN EXISTING SEWERS:

THE CONTRACTOR IS RESPONSIBLE FOR HANDLING AND ACCOMMODATING ALL EXISTING WASTEWATER FLOWS DURING THE WORK. THE CONTRACTOR WILL BE REQUIRED TO SUBMIT, FOR APPROVAL BY THE ENGINEER, A DETAILED PLAN OF THE METHOD THE CONTRACTOR PROPOSES TO MAINTAIN THE EXISTING FLOW DURING CONSTRUCTION. THE PLAN MUST INCLUDE A PROVISION FOR HANDLING THE EXISTING PEAK FLOW BY PUMPING- THE PEAK FLOW SHALL BE CONSIDERED THE EXISTING PIPE FLOWING FULL, WHICH IS HIGHLY POSSIBLE DURING RAIN EVENTS. WHEN PUMPING IS USED, AN IDENTICAL STANDBY PUMP(S) SHALL BE ON SITE IN THE EVENT OF FAILURE OF THE PRIMARY PUMP(S).

IF, AT ANY TIME DURING CONSTRUCTION, EFFLUENT FROM THE EXISTING SEWER IS NOT FULLY CONTAINED BY THE BYPASS SYSTEM, GRAVITY SERVICE WILL BE RESTORED AND WORK SHALL BE SUSPENDED UNTIL THE PROBLEM IS RESOLVED TO THE SATISFACTION OF THE ENGINEER. THIS INCLUDES WASTEWATER FLOWING INTO TRENCHES DURING EXCAVATION WORK. SEWER SYSTEM OVERFLOWS WILL NOT BE TOLERATED. ALL FINES IMPOSED ON THE OWNER AND ASSOCIATED WITH OVERFLOWS CAUSED BY THE CONTRACTOR'S WORK SHALL BE PAID BY THE CONTRACTOR.

MANHOLES EMPLOYED AS SUCTION MANHOLES OR DISCHARGE MANHOLES FOR TEMPORARY BYPASS PUMPING OPERATIONS SHALL BE TEMPORARILY RAISED TO A MINIMUM OF TWO FEET ABOVE THE EFFECTIVE 100-YEAR FLOOD ELEVATION USING MANHOLE RISER SECTIONS. JOINTS BETWEEN THE EXISTING MANHOLE AND THE TEMPORARY RISER SECTION SHALL BE ADEQUATELY SEALED TO PREVENT WATER FROM ENTERING OR EXITING THE MANHOLE. IF THIS IS NOT FEASIBLE FOR A GIVEN LOCATION, THE CONTRACTOR MAY PROPOSE ALTERNATE MEANS OF PROTECTING THE SUCTION AND DISCHARGE MANHOLES FROM INUNDATION DURING SEVERE WEATHER CONDITIONS, SUBJECT TO APPROVAL BY THE ENGINEER.

THE CONTRACTOR SHALL BE RESPONSIBLE FOR NOTIFYING TOWN OF CARY PERSONNEL PRIOR TO ANY CHANGE IN BYPASS OPERATIONAL STATUS, INCLUDING INITIATING BYPASS OPERATION, RETURNING FLOW TO NORMAL GRAVITY OPERATIONS, ETC. REFER TO THE SPECIFICATIONS FOR MORE DETAILED INFORMATION REGARDING BYPASSING REQUIREMENTS.

9. TRAFFIC CONTROL:

THE CONTRACTOR SHALL SUBMIT TO THE ENGINEER A DETAILED TRAFFIC CONTROL PLAN FOR PERFORMING ALL WORK IN ROADS AS REQUIRED BY THE NCDOT AND/OR CITY/COUNTY. THE TRAFFIC CONTROL PLAN SHALL BE SPECIFIC TO EACH ROAD AND EACH SEWER AND MANHOLE. THE TRAFFIC CONTROL PLAN SHALL BE MODIFIED AS NECESSARY IN THE FIELD TO ACCOMMODATE UNFORESEEN TRAFFIC CONTROL ISSUES AND PROBLEMS AND SAFETY CONCERNS. NO WORK SHALL BEGIN UNTIL THE TRAFFIC CONTROL PLAN IS REVIEWED AND APPROVED BY THE ENGINEER, THE CITY/COUNTY AND/OR NCDOT. WARNING SIGNS, BARRICADES AND FLAGMEN MUST BE PROVIDED IN ACCORDANCE WITH THE FEDERAL HIGHWAY ADMINISTRATION'S "MANUAL ON UNIFORM TRAFFIC CONTROL DEVICES" (MUTCD) AND NCDOT STANDARDS. ACCESS SHALL BE MAINTAINED TO HOMES, RESIDENCES, AND BUSINESSES IN THE AREA AT ALL TIMES. WHEN FLAGGING OPERATIONS ARE REQUIRED TO DIRECT MOTORISTS THROUGH THE WORK ZONE, THE CONTRACTOR SHALL EMPLOY FLAGGERS WITH APPROPRIATE NCDOT CERTIFICATION. THE CONTRACTOR SHALL PROVIDE DOCUMENTATION OF THE FLAGGERS' NCDOT CERTIFICATIONS.

THE COSTS FOR PROVIDING TRAFFIC CONTROL FOR THE SEWERS AND MANHOLES SHOWN ON THESE DRAWINGS SHALL BE INCLUDED IN THE VARIOUS UNIT PRICES BID. THE UNIT COSTS SHALL INCLUDE ANY AND ALL REQUIRED TRAFFIC CONTROL.

10. PRECONSTRUCTION VIDEO INSPECTIONS AND PHOTOGRAPHY:

THE CONTRACTOR SHALL BE RESPONSIBLE FOR PERFORMING VIDEO INSPECTIONS AND TAKING PHOTOGRAPHS OF THE ENTIRE PROJECT AREA, INCLUDING ALL AREAS TO BE USED FOR TEMPORARY ACCESS, PRIOR TO PERFORMING ANY WORK AS THE CONTRACTOR DEEMS NECESSARY. THE INSPECTIONS SHALL BE NARRATED TO DOCUMENT LOCATIONS AND DATES OF THE VIDEO INSPECTIONS. THE PHOTOGRAPHS SHALL BE DATE STAMPED.

THE PURPOSE OF THE INSPECTIONS AND PHOTOGRAPHS SHALL BE TO DOCUMENT THE PRE-CONSTRUCTION CONDITIONS FOR COMPARISON WITH THE FINAL RESTORATION WORK AND WITH ANY IMPACTS TO PROPERTY/ROADS THAT OCCUR DURING THE CONSTRUCTION. IF THE CONTRACTOR FAILS TO PERFORM THOROUGH AND COMPLETE INSPECTIONS AND PHOTOGRAPHS, AND THE OWNER OR ENGINEER RECEIVES COMPLAINTS ON THE FINAL RESTORATION OR IMPACTS TO ROADS OR PROPERTY, THE CONTRACTOR SHALL BE RESPONSIBLE FOR ANY AND ALL ADDITIONAL RESTORATION AND REPAIRS AS NECESSARY TO COMPLETELY RESOLVE THE COMPLAINT/ISSUE AT NO ADDITIONAL COST TO THE OWNER.

NO WORK MAY BEGIN AND NO EQUIPMENT SHALL BE MOBILIZED TO THE JOB SITE PRIOR TO SUBMISSION OF THE VIDEO/PHOTO DOCUMENTATION AND REVIEW AND ACCEPTANCE BY THE ENGINEER. THE VIDEO/PHOTO DOCUMENTATION SHALL COVER ALL AREAS POTENTIALLY IMPACTED BY THE CONTRACTOR'S VEHICLES AND EQUIPMENT, INCLUDING ALL SECTIONS OF GREENWAY WITHIN THE PROJECT LIMITS FOR THE UPCOMING PHASE OF CONSTRUCTION.

11. CLEANUP WORK:

THE CONTRACTOR SHALL COMPLETELY CLEAN UP THE WORK SITE AT THE END OF EACH DAY.

12. STANDARD SPECIFICATIONS AND DETAILS:

ALL WORK SHALL BE IN CONFORMANCE WITH THE TOWN OF CARY STANDARD SPECIFICATIONS AND DETAILS, UNLESS SPECIFICALLY INDICATED OTHERWISE IN THE PLANS OR SPECIFICATIONS. TOWN OF CARY STANDARD SPECIFICATIONS AND DETAILS MAY BE VIEWED AT: <https://www.townofcary.org/business-development/developing-in-cary/standard-specifications-and-details>

13. GREENWAYS:

MUCH OF THE WORK IN THIS PROJECT WILL PARALLEL EXISTING GREENWAY PATHS. DIFFERENT SECTIONS OF THE GREENWAY PATHS ARE CONSTRUCTED OF CONCRETE, ASPHALT, OR STONE. THE CRABTREE CREEK GREENWAY IS NEW AND MUST BE PROTECTED DURING CONSTRUCTION WITH CONSTRUCTION MATTING. WHERE CONSTRUCTION MATTING IS USED ON CONCRETE OR ASPHALT GREENWAY PATHS, THERE SHALL BE PROTECTION (PLYWOOD, SAND, MULCH, ETC.) PLACED UNDER THE MATS TO PREVENT DAMAGE FROM THE MATS.

THE BLACK CREEK GREENWAY SHALL BE PROTECTED DURING CONSTRUCTION AND/OR REPLACED IF DAMAGED. SEE DETAILS FOR THE REPLACEMENT OF CONCRETE AND ASPHALT GREENWAY PATHS WHERE REQUIRED. STONE GREENWAY PATHS SHALL BE REPLACED WHERE REQUIRED TO MATCH THE EXISTING GREENWAY PATH. SEE SHEET C-7 FOR MORE INFORMATION.

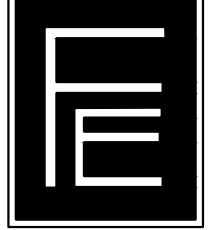
REVISIONS	CARY PROJECT No.: SW3501			TOWN OF CARY CARY, NORTH CAROLINA		SHEET No. G-1
	PROJECT No.: TOC-010			FY 20-21 SEWER REHABILITATION PROJECT		
	DESIGNED BY:			GENERAL NOTES		
	DRAWN BY: A. SPIROU					
	CHECKED BY: M. COLANGELO					
	APPROVED BY: M. LAMBERT					
DATE: MARCH 2021	Frazier Engineering, P.A. 6592 Bob White Trail Stanley, NC 28164 Office ■ 704.822.8444 Fax ■ 704.822.8666					

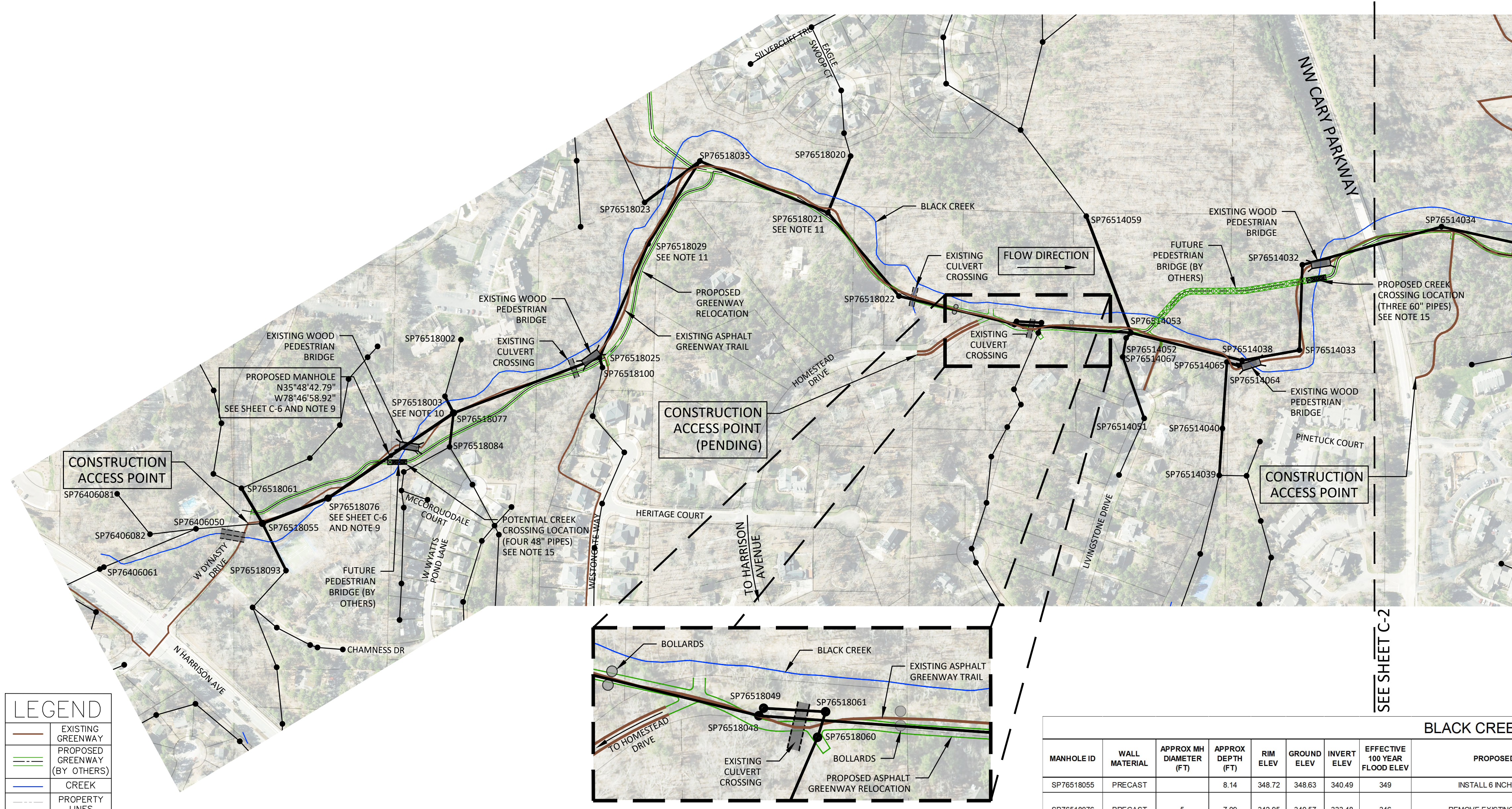

LEGEND	
	EXISTING GREENWAY
	PROPOSED GREENWAY (BY OTHERS)
	CREEK
	PROPERTY LINES

NOTES:

- ALL WORK MUST BE COMPLETED WITHIN THE EXISTING SEWER EASEMENT UNLESS APPROVED BY THE ENGINEER AND PROPERTY OWNER IN WRITING. EASEMENT WIDTHS VARY BUT CONTRACTOR SHOULD ASSUME THAT MOST EASEMENTS ARE 40 FEET WIDE UNLESS OTHERWISE SHOWN. PARTS OF THE EXISTING EASEMENT MAY NEED TO BE PREPARED IN ADVANCE OF THE WORK TO FACILITATE ACCESS. PREPARATION MAY INVOLVE STREAM BANK RESTORATION, GRADING, ETC. TO MAKE THE EASEMENT ACCESSIBLE FOR EQUIPMENT.
- REFER TO THE STANDARD DETAILS ON SHEETS D-1 THROUGH D-5 WHETHER SPECIFICALLY REFERENCED OR NOT. REFER TO THE OWNER'S STANDARD SPECIFICATIONS AND DETAILS WHETHER SPECIFICALLY REFERENCED OR NOT.
- REFER TO DETAIL 04000.11 (SHEET D-1) FOR POSSIBLE ACCESS PROCEDURES FOR CROSSING THE CREEK. ALL TEMPORARY CROSSINGS SHALL BE COMPLETELY REMOVED AND THE AREA RESTORED AT THE END OF THE WORK.
- SOME TREE LIMBS MAY NEED TO BE TRIMMED FOR ACCESS AT THE CONTRACTOR'S EXPENSE. COORDINATE WITH THE ENGINEER IN THE FIELD. ANY SIGNIFICANT TREE LIMBS THAT ARE DAMAGED THAT WERE NOT PREVIOUSLY TRIMMED OR THAT WERE NOT TRIMMED ENOUGH SHALL BE REMOVED BY THE CONTRACTOR.
- MANHOLE INSPECTIONS ARE INCOMPLETE IN THIS AREA. ADDITIONAL MANHOLE REHABILITATION MAY BE ADDED IN THE FIELD BY THE ENGINEER.
- VENTS SHALL BE INSTALLED PER DETAIL 07000.04 (SHEET D-3). VENT LOCATIONS MAY BE MOVED TO A DIFFERENT MANHOLE IN THE FIELD. VERIFY WITH THE ENGINEER BEFORE INSTALLING.
- SOME MANHOLES HAVE INCOMING LATERALS. ENGINEER WILL DIRECT WHERE INSIDE DROPS SHALL BE INSTALLED. SEE DETAIL 07000.07 (SHEET D-3).
- SEE SHEET C-7 FOR ADDITIONAL GREENWAY INFORMATION.
- CONSTRUCTION ACCESS POINTS ARE SHOWN UTILIZING EXISTING GREENWAY TRAILS WHERE APPLICABLE. IF THE GREENWAY TRAIL IS NOT SPECIFICALLY SHOWN AS AN ACCESS POINT, IT CANNOT BE USED FOR ACCESS FOR CONSTRUCTION EQUIPMENT. ANY DAMAGE TO THE GREENWAY TRAILS SHALL BE REPAIRED TO MATCH THE PRE-EXISTING CONDITIONS AT THE CONTRACTOR'S EXPENSE.
- SEE SHEET C-6 FOR THE REMOVAL OF MH-SP76518076 AND ASSOCIATED REPAIR.
- INSTALL RIP RAP ON THE CREEK BANK NEAR MH-SP76518003 AS DIRECTED BY THE ENGINEER IN THE FIELD.
- REMOVE EXISTING CLEANOUTS AND INSTALL NEW CLEANOUTS AT LOCATIONS DIRECTED BY THE ENGINEER IN THE FIELD IN THIS AREA. CLEANOUTS TO BE INSTALLED PER DETAIL 07000.09 - SHEET 3 OF 4 (SHEET D-3).
- SP76518025, SP76518035, SP76518021, AND SP76514053 HAVE AN APPROXIMATE DROP OF 2 FEET FROM THE INCOMING TRUNK SEWER TO THE OUTGOING SEWER.
- WHERE MANHOLE FLAT-TOPS OR CONES ARE REMOVED TEMPORARILY FOR CLEANING, CIPP INSTALLATION, OR OTHER ACCESS REASONS, TEMPORARY SECURITY MEASURES SHALL BE INSTALLED TO PREVENT PEDESTRIAN ACCESS IF LEFT UNATTENDED. CONTRACTOR SHALL PROVIDE A SUBMITTAL DETAILING THE TEMPORARY SECURITY MEASURES. NO MANHOLE FLAT-TOPS OR CONES AT MANHOLES THAT ARE DEEMED TO BE SUSCEPTIBLE TO FLOODING BY THE ENGINEER MAY BE REMOVED FOR TEMPORARY ACCESS UNLESS OTHERWISE APPROVED.
- WHEN REUSING A CONE OR FLAT-TOP, CONTRACTOR SHALL EXERCISE EXTREME CARE. IF THE CONE OR FLAT-TOP IS DAMAGED DUE TO NEGLIGENCE, THE CONTRACTOR SHALL PROVIDE AND INSTALL AN EQUAL REPLACEMENT COMPONENT AT NO ADDITIONAL COST TO THE OWNER. THE ENGINEER SHALL DETERMINE IF THE CONE OR FLAT-TOP WAS DAMAGED DUE TO NEGLIGENCE. THERE WILL BE NO ADDITIONAL PAYMENT FOR REUSING A CONE OR FLAT-TOP.
- THIS IS A POTENTIAL LOCATION FOR A TEMPORARY STREAM CROSSING. SEE DETAIL 04000.11 ON SHEET D-1.

BLACK CREEK 24/30 INCH INTERCEPTOR									
UPSTREAM MANHOLE	DOWNSTREAM MANHOLE	LINE ID NUMBER	PIPE MATERIAL	APPROX PIPE DIAMETER (INCHES)	APPROX LENGTH (FEET)	APPROX SLOPE (%)	PROPOSED REHABILITATION 1	PROPOSED REHABILITATION 2	CIPP THICKNESS FOR STANDARD FELT LINER (MM)
SP76518055	SP76518076	SL76518018	SPIROLITE	24	221	3.17%	INSTALL CIPP (STANDARD FELT LINER OR UV GRP); SEE SHEET C-6		12.0
SP76518076	SP76518077	SL76518030	CIPP	24	477	0.96%	INSTALL CIPP (STANDARD FELT LINER OR UV GRP); SEE SHEET C-6		9.0
SP76518077	SP76518025	SL76518061	CIPP	24	491	1.06%	NONE		N/A
SP76518025	SP76518029	SL76518052	SPIROLITE	24	388	1.23%	INSTALL CIPP (STANDARD FELT LINER OR UV GRP)		12.0
SP76518029	SP76518035	SL76518051	SPIROLITE	24	308	1.24%	INSTALL CIPP (STANDARD FELT LINER OR UV GRP)		13.5
SP76518035	SP76518021	SL76518063	SPIROLITE	30	434	0.76%	INSTALL CIPP (STANDARD FELT LINER OR UV GRP)		15.0
SP76518021	SP76518022	SL76518091	SPIROLITE	30	345	0.68%	INSTALL CIPP (STANDARD FELT LINER OR UV GRP)		15.0
SP76518022	SP76518048	SL76518093	SPIROLITE	30	375	0.18%	INSTALL CIPP (STANDARD FELT LINER OR UV GRP)		15.0
SP76518048	SP76514053	SL76514007	SPIROLITE	30	366	0.83%	INSTALL CIPP (STANDARD FELT LINER OR UV GRP)		15.0
SP76514053	SP76514038	SL76514034	SPIROLITE	30	360	0.68%	INSTALL CIPP (STANDARD FELT LINER OR UV GRP)		15.0
SP76514038	SP76514033	SL76514048	SPIROLITE	30	183	0.37%	INSTALL CIPP (STANDARD FELT LINER OR UV GRP)		15.0
SP76514033	SP76514032	SL76514047	SPIROLITE	30	268	0.99%	INSTALL CIPP (STANDARD FELT LINER OR UV GRP)		15.0
SP76514032	SP76514034	SL76514046	SPIROLITE	30	454	0.18%	INSTALL CIPP (STANDARD FELT LINER OR UV GRP)		15.0

BLACK CREEK 24/30 INCH CONNECTOR SEWERS									
UPSTREAM MANHOLE	DOWNSTREAM MANHOLE	LINE ID NUMBER	PIPE MATERIAL	APPROX PIPE DIAMETER (INCHES)	APPROX LENGTH (FEET)	APPROX SLOPE (%)	PROPOSED REHABILITATION 1	PROPOSED REHABILITATION 2	CIPP THICKNESS (MM)
SP76518061	SP76518055	SL76518011	TRUSS	8	129	NOT AVAL	CLEAN AND TELEVISION SEWER; SUBMIT FOR REVIEW	TO BE DETERMINED FROM VIDEO REVIEW	TBD
SP76518055	SP76518056	SL76518013	DIP	8	166	NOT AVAL	CLEAN AND TELEVISION SEWER; SUBMIT FOR REVIEW	TO BE DETERMINED FROM VIDEO REVIEW	TBD
SP76518056	SP76518077	SL76518032	TRUSS	8	107	NOT AVAL	CLEAN AND TELEVISION SEWER; SUBMIT FOR REVIEW	TO BE DETERMINED FROM VIDEO REVIEW	TBD
SP76518077	SP76518077	SL76518060	DIP	8	50	NOT AVAL	CLEAN AND TELEVISION SEWER; SUBMIT FOR REVIEW	TO BE DETERMINED FROM VIDEO REVIEW	TBD
SP76518100	SP76518025	SL76518108	PVC	8	32	NOT AVAL	CLEAN AND TELEVISION SEWER; SUBMIT FOR REVIEW	TO BE DETERMINED FROM VIDEO REVIEW	TBD
SP76518025	SP76518035	SL76518050	DIP	8	217	NOT AVAL	CLEAN AND TELEVISION SEWER; SUBMIT FOR REVIEW	TO BE DETERMINED FROM VIDEO REVIEW	TBD
SP76518035	SP76518021	SL76518090	DIP	8	192	NOT AVAL	CLEAN AND TELEVISION SEWER; SUBMIT FOR REVIEW	TO BE DETERMINED FROM VIDEO REVIEW	TBD
SP76518021	SP76514061	SL76514055	DIP	8	34	NOT AVAL	CLEAN AND TELEVISION SEWER; SUBMIT FOR REVIEW	TO BE DETERMINED FROM VIDEO REVIEW	TBD
SP76514061	SP76518049	SL76514054	DIP	8	78	NOT AVAL	CLEAN AND TELEVISION SEWER; SUBMIT FOR REVIEW	TO BE DETERMINED FROM VIDEO REVIEW	TBD
SP76518049	SP76518048	SL76518079	DIP	8	11	NOT AVAL	CLEAN AND TELEVISION SEWER; SUBMIT FOR REVIEW	TO BE DETERMINED FROM VIDEO REVIEW	TBD
SP76518048	SP76514067	SL76514077	TRUSS	8	205	NOT AVAL	CLEAN AND TELEVISION SEWER; SUBMIT FOR REVIEW	TO BE DETERMINED FROM VIDEO REVIEW	TBD
SP76514067	SP76514052	SL76514078	PVC	8	60	NOT AVAL	CLEAN AND TELEVISION SEWER; SUBMIT FOR REVIEW	TO BE DETERMINED FROM VIDEO REVIEW	TBD
SP76514052	SP76514053	SL76514065	DIP	8	22	NOT AVAL	CLEAN AND TELEVISION SEWER; SUBMIT FOR REVIEW	TO BE DETERMINED FROM VIDEO REVIEW	TBD
SP76514053	SP76514053	SL76514058	PVC	12	392	NOT AVAL	CLEAN AND TELEVISION SEWER; SUBMIT FOR REVIEW	TO BE DETERMINED FROM VIDEO REVIEW	TBD
SP76514058	SP76514040	SL76514080	TRUSS	8	148	NOT AVAL	CLEAN AND TELEVISION SEWER; SUBMIT FOR REVIEW	TO BE DETERMINED FROM VIDEO REVIEW	TBD
SP76514040	SP76514065	SL76514079	DIP	8	209	NOT AVAL	CLEAN AND TELEVISION SEWER; SUBMIT FOR REVIEW	TO BE DETERMINED FROM VIDEO REVIEW	TBD
SP76514065	SP76514064	SL76514070	TRUSS	8	42	NOT AVAL	CLEAN AND TELEVISION SEWER; SUBMIT FOR REVIEW	TO BE DETERMINED FROM VIDEO REVIEW	TBD
SP76514064	SP76514038	SL76514071	TRUSS	8	20	NOT AVAL	CLEAN AND TELEVISION SEWER; SUBMIT FOR REVIEW	TO BE DETERMINED FROM VIDEO REVIEW	TBD

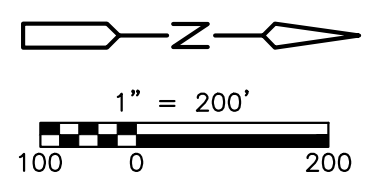

BLACK CREEK 24/30 INCH MANHOLES										
MANHOLE ID	WALL MATERIAL	APPROX MH DIAMETER (FT)	APPROX DEPTH (FT)	RIM ELEV	GROUND ELEV	INVERT ELEV	EFFECTIVE 100 YEAR FLOOD ELEV	PROPOSED REHABILITATION 1	PROPOSED REHABILITATION 2	PROPOSED REHABILITATION 3
SP76518055	PRECAST		8.14	348.72	348.63	340.49	349	INSTALL 6 INCH CONCRETE GRADE RING	INSTALL WATERTIGHT FRAME AND COVER (TYPE 2A)	
SP76518076	PRECAST	5	7.09	342.95	340.57	333.48	346	REMOVE EXISTING MANHOLE; SEE SHEET C-6	INSTALL NEW MANHOLE; SEE SHEET C-6	
SP76518077	PRECAST	5	8.39	339.25	337.29	328.90	340		INSTALL WATERTIGHT FRAME AND COVER (TYPE 2A)	INSTALL NEW VENT; VENT OPENING ELEVATION SHALL BE 342 OR A MIN OF 2 FEET HIGHER THAN FINAL RIM ELEVATION, WHICHEVER IS HIGHER
SP76518025	PRECAST	5	9.00	333.09	332.71	323.71	335	INSTALL 1 FOOT RISER SECTION; REUSE CONE; SEE NOTE 14		
SP76518029	PRECAST	5	9.28	330.02	328.23	318.95	330		INSTALL WATERTIGHT FRAME AND COVER (TYPE 2A)	REMOVE EXISTING VENT AND PLUG HOLE WITH CONCRETE
SP76518035	PRECAST	6	12.25	328.96	327.39	315.14	328	INSTALL 2 FOOT RISER SECTION; REUSE CONE; SEE NOTE 14	INSTALL WATERTIGHT FRAME AND COVER (TYPE 2A)	
SP76518021	PRECAST	5	9.06	321.64	320.90	311.84	328	INSTALL 4 FOOT CONE; ROTATE CONE AWAY FROM TRAIL	INSTALL WATERTIGHT FRAME AND COVER (TYPE 2A)	
SP76518022	PRECAST	5	10.69	321.84	320.19	309.50	326		INSTALL WATERTIGHT FRAME AND COVER (TYPE 2A)	
SP76518048	PRECAST	5	15.04	323.61	323.87	308.83	322			
SP76514053	PRECAST	6	11.86	319.56	317.67	305.81	320	INSTALL 3 FOOT RISER SECTION; REUSE CONE; ROTATE CONE AWAY FROM TRAIL; SEE NOTE 14	INSTALL WATERTIGHT FRAME AND COVER (TYPE 2A)	
SP76514038	PRECAST	5	8.35	314.00	311.70	303.35	318		INSTALL WATERTIGHT FRAME AND COVER (TYPE 2A)	INSTALL NEW VENT; VENT OPENING ELEVATION SHALL BE 320 OR A MIN OF 2 FEET HIGHER THAN FINAL RIM ELEVATION, WHICHEVER IS HIGHER
SP76514033	PRECAST	5	9.51	313.24	312.18	302.67	316		INSTALL WATERTIGHT FRAME AND COVER (TYPE 2A)	
SP76514032	PRECAST	6	10.78	311.10	310.78	300.00	315		INSTALL WATERTIGHT FRAME AND COVER (TYPE 2A)	

BLACK CREEK 24/30 INCH CONNECTOR MANHOLES										
MANHOLE ID	WALL MATERIAL	APPROX MH DIAMETER (FT)	APPROX DEPTH (FT)	RIM ELEV	GROUND ELEV	INVERT ELEV	EFFECTIVE 100 YEAR FLOOD ELEV	PROPOSED REHABILITATION 1	PROPOSED REHABILITATION 2	PROPOSED REHABILITATION 3
SP76518061										
SP76518093										
SP76518084										
SP76518003								INSTALL WATERTIGHT FRAME AND COVER (TYPE 2A)		
SP76518100										
SP76518023										
SP76518020										
SP76514060								INSTALL WATERTIGHT FRAME AND COVER (TYPE 2A)		
SP76514051								INSTALL WATERTIGHT FRAME AND COVER (TYPE 2A)		
SP76518049										
SP76514052										
SP76514059										
SP76514039										
SP76514040										
SP76514065								INSTALL WATERTIGHT FRAME AND COVER (TYPE 2A)		
SP76514064								INSTALL WATERTIGHT FRAME AND COVER (TYPE 2A)		

REVISIONS	CARY PROJECT No.: SW3501
	PROJECT No.: TOC-010
	DESIGNED BY:
	DRAWN BY: A. SPIROU
	CHECKED BY: M. COLANGELO
	APPROVED BY: M. LAMBERT
	DATE: MARCH 2021

Frazier Engineering, P.A.
 6592 Bob White Trail
 Stanley, NC 28164
 Office 704.822.8444
 Fax 704.822.8666

TOWN OF CARY
 CARY, NORTH CAROLINA

FY 20-21 SEWER REHABILITATION PROJECT

BLACK CREEK 24"/30" INTERCEPTOR

SHEET No. **C-1**

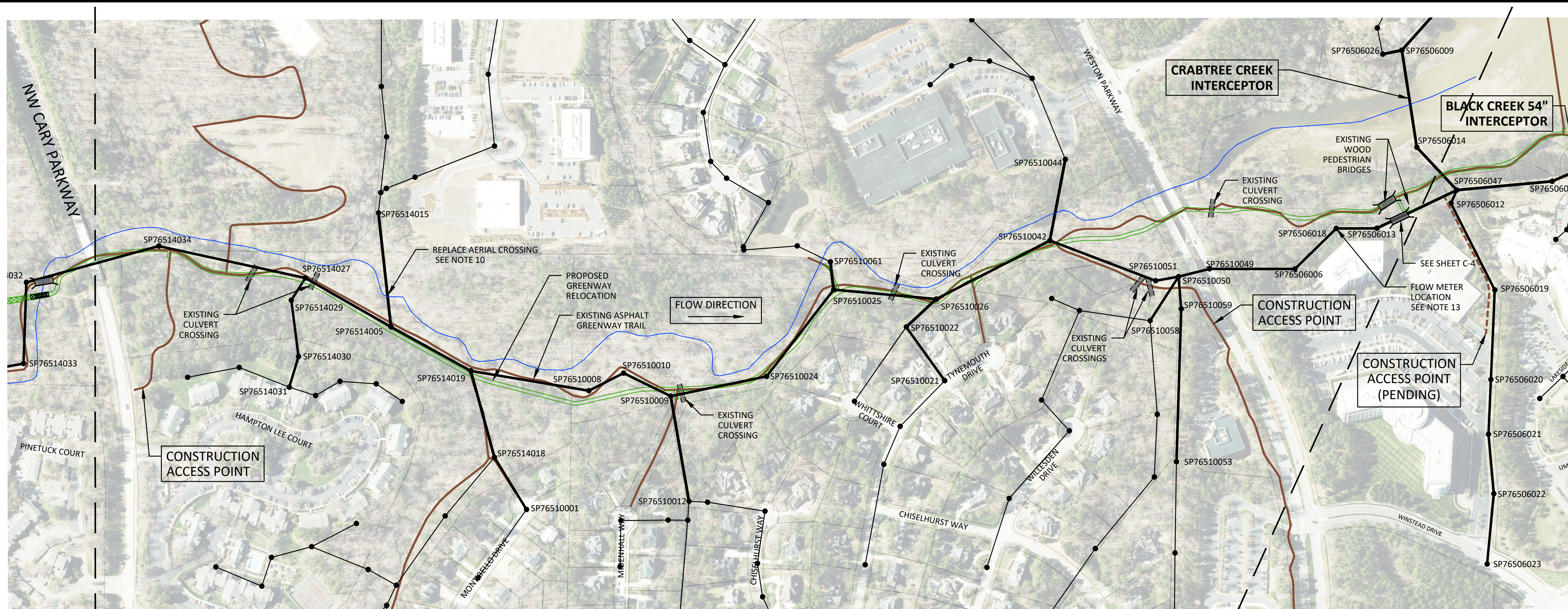

- NOTES:**
- ALL WORK MUST BE COMPLETED WITHIN THE EXISTING SEWER EASEMENT UNLESS APPROVED BY THE ENGINEER AND PROPERTY OWNER IN WRITING. EASEMENT WIDTHS VARY BUT CONTRACTOR SHOULD ASSUME THAT MOST EASEMENTS ARE 40 FEET WIDE UNLESS OTHERWISE SHOWN. PARTS OF THE EXISTING EASEMENT MAY NEED TO BE PREPARED IN ADVANCE OF THE WORK TO FACILITATE ACCESS. PREPARATION MAY INVOLVE STREAM BANK RESTORATION, GRADING, ETC. TO MAKE THE EASEMENT ACCESSIBLE FOR EQUIPMENT.
REFER TO THE STANDARD DETAILS ON SHEETS D-1 THROUGH D-5 WHETHER SPECIFICALLY REFERENCED OR NOT. REFER TO THE OWNER'S STANDARD SPECIFICATIONS AND DETAILS WHETHER SPECIFICALLY REFERENCED OR NOT.
 - REFER TO DETAIL 04000.11 (SHEET D-1) FOR POSSIBLE ACCESS PROCEDURES FOR CROSSING THE CREEK. ALL TEMPORARY CROSSINGS SHALL BE COMPLETELY REMOVED AND THE AREA RESTORED AT THE END OF THE WORK.
 - SOME TREE LIMBS MAY NEED TO BE TRIMMED FOR ACCESS AT THE CONTRACTOR'S EXPENSE. COORDINATE WITH THE ENGINEER IN THE FIELD. ANY SIGNIFICANT TREE LIMBS THAT ARE DAMAGED THAT WERE NOT PREVIOUSLY TRIMMED OR THAT WERE NOT TRIMMED ENOUGH SHALL BE REMOVED BY THE CONTRACTOR.
 - MANHOLE INSPECTIONS ARE INCOMPLETE IN THIS AREA. ADDITIONAL MANHOLE REHABILITATION MAY BE ADDED IN THE FIELD BY THE ENGINEER.
 - VENTS SHALL BE INSTALLED PER DETAIL 07000.04 (SHEET D-3). VENT LOCATIONS MAY BE MOVED TO A DIFFERENT MANHOLE IN THE FIELD. VERIFY WITH THE ENGINEER BEFORE INSTALLING.
 - SOME MANHOLES HAVE INCOMING LATERALS. ENGINEER WILL DIRECT WHERE INSIDE DROPS SHALL BE INSTALLED. SEE DETAIL 07000.07 (SHEET D-3).
 - SEE SHEET C-7 FOR ADDITIONAL GREENWAY INFORMATION.
 - CONSTRUCTION ACCESS POINTS ARE SHOWN UTILIZING EXISTING GREENWAY TRAILS WHERE APPLICABLE. IF THE GREENWAY TRAIL IS NOT SPECIFICALLY SHOWN AS AN ACCESS POINT, IT CANNOT BE USED FOR ACCESS FOR CONSTRUCTION EQUIPMENT. ANY DAMAGE TO THE GREENWAY TRAILS SHALL BE REPAIRED TO MATCH THE PRE-EXISTING CONDITIONS AT THE CONTRACTOR'S EXPENSE.
 - SP76510025 AND SP76510042 HAVE AN APPROXIMATE DROP OF 2 FEET FROM THE INCOMING TRUNK SEWER TO THE OUTGOING SEWER.
 - REPLACE EXISTING AERIAL SEWER WITH NEW STEEL PIPE PER DETAIL 07000.18 - SHEET 1 OF 2 (MODIFIED) ON SHEET D-3.
 - WHERE MANHOLE FLATTOPS OR CONES ARE REMOVED TEMPORARILY FOR CLEANING, CIPP INSTALLATION, OR OTHER ACCESS REASONS, TEMPORARY SECURITY MEASURES SHALL BE INSTALLED TO PREVENT PEDESTRIAN ACCESS IF LEFT UNATTENDED. CONTRACTOR SHALL PROVIDE A SUBMITTAL DETAILING THE TEMPORARY SECURITY MEASURES. NO MANHOLE FLATTOPS OR CONES AT MANHOLES THAT ARE DEEMED TO BE SUSCEPTIBLE TO FLOODING BY THE ENGINEER MAY BE REMOVED FOR TEMPORARY ACCESS UNLESS OTHERWISE APPROVED.
 - WHEN REUSING A CONE OR FLAT-TOP, CONTRACTOR SHALL EXERCISE EXTREME CARE. IF THE CONE OR FLAT-TOP IS DAMAGED DUE TO NEGLIGENCE, THE CONTRACTOR SHALL PROVIDE AND INSTALL AN EQUAL REPLACEMENT COMPONENT AT NO ADDITIONAL COST TO THE OWNER. THE ENGINEER SHALL DETERMINE IF THE CONE OR FLAT-TOP WAS DAMAGED DUE TO NEGLIGENCE. THERE WILL BE NO ADDITIONAL PAYMENT FOR REUSING A CONE OR FLAT-TOP.
 - FLOW METER IS INSTALLED IN MH-SP76506018. PROVIDE 30 DAYS NOTICE TO THE ENGINEER BEFORE ANY ACTIVITY AT THIS MANHOLE (INCLUDING CLEANING THE SEWER, CIPP INSTALLATION, MANHOLE REHABILITATION, ETC.) SO THAT THE FLOW METER CAN BE REMOVED. FLOW DATA FROM THIS FLOW METER INDICATES AN AVERAGE FLOW OF APPROXIMATELY 1.1 MGD AND A PEAK FLOW OF APPROXIMATELY 3.9 MGD. THIS DATA IS PROVIDED AS GENERAL INFORMATION ONLY. THE BY-PASS PUMPING SYSTEM SHALL BE SIZED ACCORDING TO THE SPECIFICATIONS.

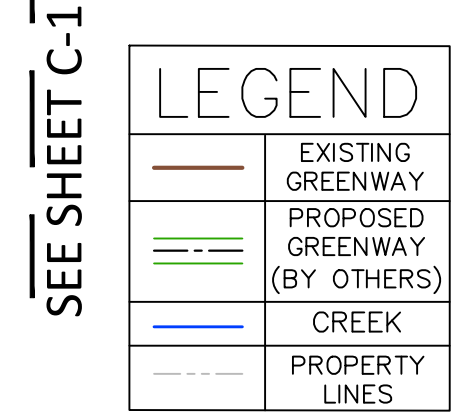

BLACK CREEK 24/30 INCH INTERCEPTOR

UPSTREAM MANHOLE	DOWNSTREAM MANHOLE	LINE ID NUMBER	PIPE MATERIAL	APPROX PIPE DIAMETER (INCHES)	APPROX LENGTH (FEET)	APPROX SLOPE (%)	PROPOSED REHABILITATION 1	PROPOSED REHABILITATION 2	CIPP THICKNESS FOR STANDARD FELT LINER (MM)
SP76514034	SP76514027	SL76514032	SPIROLITE	30	495	0.75%	INSTALL CPP (STANDARD FELT LINER OR UV GRP)		15.0
SP76514027	SP76514005	SL76514017	SPIROLITE	30	325	0.13%	INSTALL CPP (STANDARD FELT LINER OR UV GRP)		15.0
SP76514005	SP76514019	SL76514014	SPIROLITE	30	301	0.72%	INSTALL CPP (STANDARD FELT LINER OR UV GRP)		15.0
SP76514019	SP76510008	SL76510015	SPIROLITE	30	395	1.61%	INSTALL CPP (STANDARD FELT LINER OR UV GRP)		15.0
SP76510008	SP76510010	SL76510010	SPIROLITE	30	129	0.21%	INSTALL CPP (STANDARD FELT LINER OR UV GRP)		15.0
SP76510010	SP76510009	SL76510011	SPIROLITE	30	173	0.24%	INSTALL CPP (STANDARD FELT LINER OR UV GRP)		15.0
SP76510009	SP76510024	SL76510006	SPIROLITE	30	323	0.20%	INSTALL CPP (STANDARD FELT LINER OR UV GRP)		16.5
SP76510024	SP76510025	SL76510037	SPIROLITE	30	362	0.94%	INSTALL CPP (STANDARD FELT LINER OR UV GRP)		16.5
SP76510025	SP76510026	SL76510038	SPIROLITE	30	340	0.10%	INSTALL CPP (STANDARD FELT LINER OR UV GRP)		15.0
SP76510026	SP76510042	SL76510020	SPIROLITE	30	422	1.16%	INSTALL CPP (STANDARD FELT LINER OR UV GRP)		15.0
SP76510042	SP76510051	SL76510017	SPIROLITE	30	374	-0.22%	INSTALL CPP (STANDARD FELT LINER OR UV GRP)		15.0
SP76510051	SP76510050	SL76510030	SPIROLITE	30	77	1.45%	INSTALL CPP (STANDARD FELT LINER OR UV GRP)		16.5
SP76510050	SP76510049	SL76510031	SPIROLITE	30	105	0.04%	INSTALL CPP (STANDARD FELT LINER OR UV GRP)		19.5
SP76510049	SP76506006	SL76510056	SPIROLITE	30	282	0.16%	INSTALL CPP (STANDARD FELT LINER OR UV GRP)		19.5
SP76506006	SP76506018	SL76506024	SPIROLITE	30	191	0.20%	INSTALL CPP (STANDARD FELT LINER OR UV GRP)		16.5
SP76506018	SP76506013	SL76506006	SPIROLITE	30	134	0.91%	INSTALL CPP (STANDARD FELT LINER OR UV GRP)		16.5
SP76506013	SP76506047	SL76506022	SPIROLITE	30	293	2.38%	INSTALL CPP (STANDARD FELT LINER OR UV GRP)		16.5

BLACK CREEK 24/30 INCH CONNECTOR SEWERS

UPSTREAM MANHOLE	DOWNSTREAM MANHOLE	LINE ID NUMBER	PIPE MATERIAL	APPROX PIPE DIAMETER (INCHES)	APPROX LENGTH (FEET)	APPROX SLOPE (%)	PROPOSED REHABILITATION 1	PROPOSED REHABILITATION 2	CIPP THICKNESS (MM)
SP76514031	SP76514030	SL76514023	TRUSS	8	105	NOT AVAL	CLEAN AND TELEWISE SEWER. SUBMIT FOR REVIEW	TO BE DETERMINED FROM VIDEO REVIEW	TBD
SP76514030	SP76514029	SL76514019	PVC	8	188	NOT AVAL	CLEAN AND TELEWISE SEWER. SUBMIT FOR REVIEW	TO BE DETERMINED FROM VIDEO REVIEW	TBD
SP76514029	SP76514027	SL76514033	TRUSS	8	87	NOT AVAL	CLEAN AND TELEWISE SEWER. SUBMIT FOR REVIEW	TO BE DETERMINED FROM VIDEO REVIEW	TBD
SP76514015	SP76514005	SL76514050	DIP	8	378	NOT AVAL	REMOVE AERIAL CROSSING AND REPLACE WITH STEEL PIPE; SEE NOTE 10	CLEAN AND TELEWISE SEWER. SUBMIT FOR REVIEW	TBD
SP76510001	SP76514018	SL76514005	TRUSS	8	202	NOT AVAL	CLEAN AND TELEWISE SEWER. SUBMIT FOR REVIEW	TO BE DETERMINED FROM VIDEO REVIEW	TBD
SP76514018	SP76514019	SL76514006	TRUSS/DIP	8	295	NOT AVAL	CLEAN AND TELEWISE SEWER. SUBMIT FOR REVIEW	TO BE DETERMINED FROM VIDEO REVIEW	TBD
SP76510012	SP76510009	SL76510003	DIP	8	352	NOT AVAL	CLEAN AND TELEWISE SEWER. SUBMIT FOR REVIEW	TO BE DETERMINED FROM VIDEO REVIEW	TBD
SP76510061	SP76510025	SL76510064	DIP	8	93	NOT AVAL	CLEAN AND TELEWISE SEWER. SUBMIT FOR REVIEW	TO BE DETERMINED FROM VIDEO REVIEW	TBD
SP76510021	SP76510022	SL76510026	TRUSS	8	218	NOT AVAL	CLEAN AND TELEWISE SEWER. SUBMIT FOR REVIEW	TO BE DETERMINED FROM VIDEO REVIEW	TBD
SP76510022	SP76510026	SL76510027	TRUSS	8	135	NOT AVAL	CLEAN AND TELEWISE SEWER. SUBMIT FOR REVIEW	TO BE DETERMINED FROM VIDEO REVIEW	TBD
SP76510044	SP76510042	SL76510045	DIP	8	273	NOT AVAL	CLEAN AND TELEWISE SEWER. SUBMIT FOR REVIEW	TO BE DETERMINED FROM VIDEO REVIEW	TBD
SP76510058	SP76510050	SL76510029	TRUSS	8	173	NOT AVAL	CLEAN AND TELEWISE SEWER. SUBMIT FOR REVIEW	TO BE DETERMINED FROM VIDEO REVIEW	TBD
SP76510053	SP76510059	SL76510084	TRUSS	8	505	NOT AVAL	CLEAN AND TELEWISE SEWER. SUBMIT FOR REVIEW	TO BE DETERMINED FROM VIDEO REVIEW	TBD
SP76510059	SP76510050	SL76510085	TRUSS	8	106	NOT AVAL	CLEAN AND TELEWISE SEWER. SUBMIT FOR REVIEW	TO BE DETERMINED FROM VIDEO REVIEW	TBD

BLACK CREEK 24/30 INCH MANHOLES

MANHOLE ID	WALL MATERIAL	APPROX MH DIAMETER (FT)	APPROX DEPTH (FT)	RIM ELEV	GROUND ELEV	INVERT ELEV	EFFECTIVE 100 YEAR FLOOD ELEV	PROPOSED REHABILITATION 1	PROPOSED REHABILITATION 2	PROPOSED REHABILITATION 3
SP76514034	PRECAST	5	7.39	308.26	308.57	299.18	312	INSTALL 1 FOOT RISER SECTION; REUSE FLAT-TOP; SEE NOTE 12	INSTALL WATERTIGHT FRAME AND COVER (TYPE 2A)	
SP76514027	PRECAST	5	8.66	305.94	304.11	295.45	308	INSTALL 1 FOOT RISER SECTION AND 6 INCH CONCRETE GRADE RING; REUSE FLAT-TOP; SEE NOTE 12	INSTALL WATERTIGHT FRAME AND COVER (TYPE 2A)	
SP76514005	PRECAST	5	7.19	305.29	302.23	295.04	305	INSTALL 1 FOOT RISER SECTION; REUSE FLAT-TOP; SEE NOTE 12	INSTALL WATERTIGHT FRAME AND COVER (TYPE 2A)	
SP76514019	PRECAST	5	6.83	302.50	299.70	292.87	303	INSTALL 4 FOOT RISER SECTION; REUSE FLAT-TOP; SEE NOTE 12	INSTALL WATERTIGHT FRAME AND COVER (TYPE 2A)	
SP76510008	PRECAST	5	9.85	300.34	296.34	286.49	301		INSTALL WATERTIGHT FRAME AND COVER (TYPE 2A)	
SP76510010	PRECAST	5	10.11	300.04	296.33	286.22	298		INSTALL WATERTIGHT FRAME AND COVER (TYPE 2A)	
SP76510009	PRECAST	5	10.29	298.38	296.09	285.80	299	INSTALL 2 FOOT RISER SECTION; REUSE CONE; SEE NOTE 12	INSTALL WATERTIGHT FRAME AND COVER (TYPE 2A)	
SP76510024	PRECAST	4 AND 6	12.81	302.92	297.76	285.15	297		INSTALL WATERTIGHT FRAME AND COVER (TYPE 2A)	
SP76510025	PRECAST	5	8.44	291.03	290.19	281.75	295	INSTALL 2 FOOT RISER SECTION AND FLAT TOP	INSTALL WATERTIGHT FRAME AND COVER (TYPE 2A)	
SP76510026	PRECAST	5	9.59	294.94	291.01	281.42	292		INSTALL WATERTIGHT FRAME AND COVER (TYPE 2A)	REMOVE EXISTING VENT AND PLUG HOLE WITH CONCRETE
SP76510042	PRECAST	8	8.91	286.76	285.42	278.51	288	INSTALL 4 INCH CONCRETE GRADE RING	INSTALL WATERTIGHT FRAME AND COVER (TYPE 2A)	
SP76510051	PRECAST	6	7.31	286.17	284.63	277.32	286		INSTALL WATERTIGHT FRAME AND COVER (TYPE 2A)	
SP76510050	PRECAST		13.47	290.33	289.67	276.20	288		INSTALL WATERTIGHT FRAME AND COVER (TYPE 2A)	INSTALL NEW VENT; VENT OPENING ELEVATION SHALL BE 288 OR A MIN OF 2 FEET HIGHER THAN FINAL RM ELEVATION, WHICHEVER IS HIGHER
SP76510049	PRECAST	6	25.62	301.74	301.78	276.16	288		INSTALL WATERTIGHT FRAME AND COVER (TYPE 2A)	
SP76506006	PRECAST	4 AND 6	11.30	289.49	287.00	275.70	283		INSTALL WATERTIGHT FRAME AND COVER (TYPE 2A)	
SP76506018	PRECAST	4 AND 6	12.73	291.27	288.05	275.32	283		INSTALL WATERTIGHT FRAME AND COVER (TYPE 2A)	
SP76506013	PRECAST	4 AND 6	13.82	289.33	287.92	274.10	283		INSTALL WATERTIGHT FRAME AND COVER (TYPE 2A)	

BLACK CREEK 24/30 INCH CONNECTOR MANHOLES

MANHOLE ID	WALL MATERIAL	APPROX MH DIAMETER (FT)	APPROX DEPTH (FT)	RIM ELEV	GROUND ELEV	INVERT ELEV	EFFECTIVE 100 YEAR FLOOD ELEV	PROPOSED REHABILITATION 1	PROPOSED REHABILITATION 2	PROPOSED REHABILITATION 3
SP76514031										
SP76514030										
SP76514029										
SP76514015										
SP76510001										
SP76514018										
SP76510012										
SP76510061										
SP76510021										
SP76510022										
SP76510044										
SP76510058										
SP76510053										
SP76510059										

INFORMATION PRESENTLY NOT AVAILABLE

SEE NOTE 4 FOR ALL CONNECTOR MANHOLES

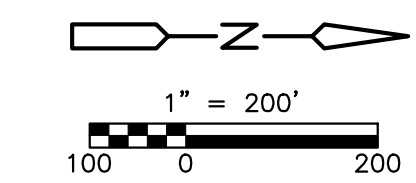

REVISIONS 	CARY PROJECT No.: SW3501		TOWN OF CARY CARY, NORTH CAROLINA	SHEET No. C-2
	PROJECT No.: TOC-010		FY 20-21 SEWER REHABILITATION PROJECT	
	DESIGNED BY:		BLACK CREEK 24"/30" INTERCEPTOR	
	DRAWN BY: A. SPIROU		Frazier Engineering, P.A. 6592 Bob White Trail Stanley, NC 28164 Office 704.822.8444 Fax 704.822.8666	
	CHECKED BY: M. COLANGELO		APPROVED BY: M. LAMBERT	
DATE: MARCH 2021				

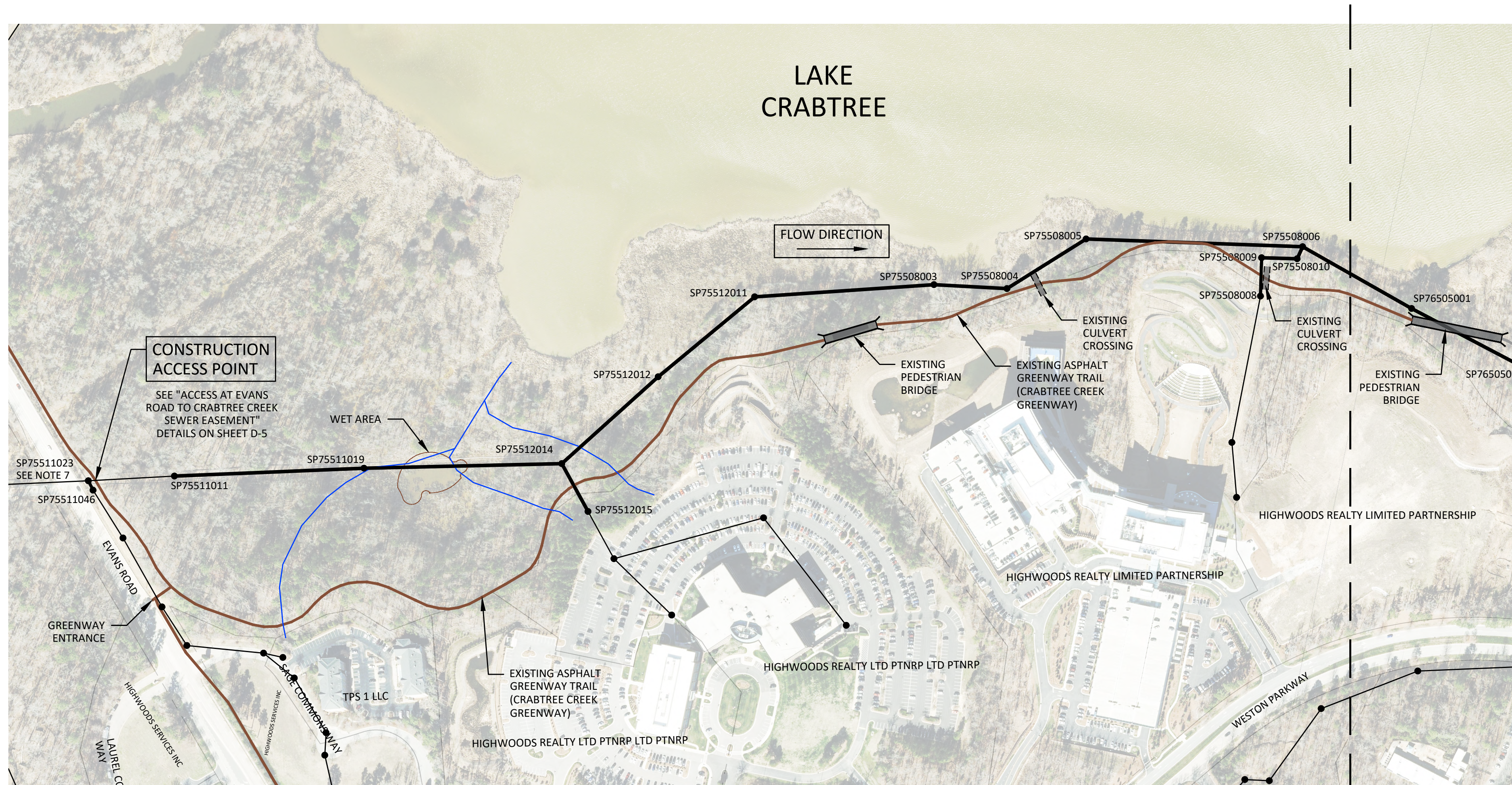

NOTES:

- ALL WORK MUST BE COMPLETED WITHIN THE EXISTING SEWER EASEMENT UNLESS APPROVED BY THE ENGINEER AND PROPERTY OWNER IN WRITING. EASEMENT WIDTHS VARY BUT CONTRACTOR SHOULD ASSUME THAT MOST EASEMENTS ARE 40 FEET WIDE UNLESS OTHERWISE SHOWN. PARTS OF THE EXISTING EASEMENT MAY NEED TO BE PREPARED IN ADVANCE OF THE WORK TO FACILITATE ACCESS. PREPARATION MAY INVOLVE STREAM BANK RESTORATION, GRADING, ETC. TO MAKE THE EASEMENT ACCESSIBLE FOR EQUIPMENT. REFER TO THE STANDARD DETAILS ON SHEETS D-1 THROUGH D-5 WHETHER SPECIFICALLY REFERENCED OR NOT. REFER TO THE OWNER'S STANDARD SPECIFICATIONS AND DETAILS WHETHER SPECIFICALLY REFERENCED OR NOT.
- SOME TREE LIMBS MAY NEED TO BE TRIMMED FOR ACCESS AT THE CONTRACTOR'S EXPENSE. COORDINATE WITH THE ENGINEER IN THE FIELD. ANY SIGNIFICANT TREE LIMBS THAT ARE DAMAGED THAT WERE NOT PREVIOUSLY TRIMMED OR THAT WERE NOT TRIMMED ENOUGH SHALL BE REMOVED BY THE CONTRACTOR.
- MANHOLE INSPECTIONS ARE INCOMPLETE IN THIS AREA. ADDITIONAL MANHOLE REHABILITATION MAY BE ADDED IN THE FIELD BY THE ENGINEER.
- SEE SHEET C-7 FOR ADDITIONAL GREENWAY INFORMATION.
- CONSTRUCTION ACCESS POINTS ARE SHOWN UTILIZING EXISTING GREENWAY TRAILS WHERE APPLICABLE. IF THE GREENWAY TRAIL IS NOT SPECIFICALLY SHOWN AS AN ACCESS POINT, IT CANNOT BE USED FOR ACCESS FOR CONSTRUCTION EQUIPMENT. ANY DAMAGE TO THE GREENWAY TRAILS SHALL BE REPAIRED TO MATCH THE PRE-EXISTING CONDITIONS AT THE CONTRACTOR'S EXPENSE.
- CONTRACTOR SHALL MARK THE CENTERLINE OF THE EXISTING CRABTREE CREEK INTERCEPTOR AT 50 FOOT INTERVALS FROM SP75511023 TO SP75508004 DUE TO THE SHALLOW DEPTH OF THE SEWER. NO EQUIPMENT CAN TRAVEL WITHIN 10 FEET OF THE CENTERLINE OF THE SEWER AT ANY TIME.
- SEE DETAIL D ON SHEET D-4 FOR MODIFICATIONS NECESSARY TO MH-SP75511023 TO ACCOMMODATE SUCTION FOR BY-PASS PUMPING.
- SP75511011 AND SP75511019 ARE LINED WITH EPOXY. CAREFULLY CUT THROUGH THE EPOXY APPROXIMATELY 3 INCHES BELOW THE JOINT WHERE THE EXISTING RISER OR FLAT-TOP WILL BE REMOVED AND REPLACED. AFTER THE NEW RISER AND/OR FLAT-TOP HAVE BEEN INSTALLED, APPLY NON-SHRINK GROUT TO JOINT BETWEEN THE EXISTING RISER AND NEW RISER OR FLAT-TOP.
- THE FINAL FLAT-TOP ELEVATION FOR SP75511011, SP75511019, AND SP75508006 SHALL BE A MINIMUM OF 2 FEET ABOVE THE HIGHEST GROUND ELEVATION AT THE MANHOLE. IT IS THE CONTRACTOR'S RESPONSIBILITY TO INVESTIGATE/MEASURE THE EXISTING MANHOLES SO THAT THE CORRECT RISER SECTIONS ARE INSTALLED TO MEET THIS REQUIREMENT WITHOUT THE INSTALLATION OF CONCRETE "DOUGHNUTS". IT IS ACCEPTABLE TO BE HIGHER THAN 2 FEET ABOVE GRADE BY USING RISER SECTIONS ONLY BUT THE HEIGHT ABOVE 2 FEET ABOVE GRADE SHALL BE MINIMIZED TO THE EXTENT POSSIBLE.
- WHERE MANHOLE FLAT-TOPS OR CONES ARE REMOVED TEMPORARILY FOR CLEANING, CIPP INSTALLATION, OR OTHER ACCESS REASONS, TEMPORARY SECURITY MEASURES SHALL BE INSTALLED TO PREVENT PEDESTRIAN ACCESS IF LEFT UNATTENDED. CONTRACTOR SHALL PROVIDE A SUBMITTAL DETAILING THE TEMPORARY SECURITY MEASURES. NO MANHOLE FLAT-TOPS OR CONES AT MANHOLES THAT ARE DEEMED TO BE SUSCEPTIBLE TO FLOODING BY THE ENGINEER MAY BE REMOVED FOR TEMPORARY ACCESS UNLESS OTHERWISE APPROVED.
- CONTRACTOR SHALL PROVIDE SURVEYING SERVICES AS NECESSARY TO ENSURE THAT THE VENT OPENING IS PLACED AT THE CORRECT ELEVATION.

CRABTREE CREEK INTERCEPTOR

UPSTREAM MANHOLE	DOWNSTREAM MANHOLE	LINE ID NUMBER	PIPE MATERIAL	APPROX PIPE DIAMETER (INCHES)	APPROX LENGTH (FEET)	APPROX SLOPE (%)	PROPOSED REHABILITATION 1	PROPOSED REHABILITATION 2	CIPP THICKNESS FOR FIBERGLASS REINFORCED FELT (MM)
SP75511011	SP75511019	SL75511022	DIP	48	496	0.10%	INSTALL CIPP (FIBERGLASS REINFORCED FELT LINER OR UV GRP)		23.5
SP75511019	SP75512014	SL75512012	DIP	48	508	0.08%	INSTALL CIPP (FIBERGLASS REINFORCED FELT LINER OR UV GRP)		19.5
SP75512014	SP75512012	SL75512008	DIP	48	341	0.02%	INSTALL CIPP (FIBERGLASS REINFORCED FELT LINER OR UV GRP)		19.5
SP75512012	SP75512011	SL75512007	RCP	48	324	0.02%	INSTALL CIPP (FIBERGLASS REINFORCED FELT LINER OR UV GRP)		18.0
SP75512011	SP75508003	SL75508001	RCP	48	472	0.03%	INSTALL CIPP (FIBERGLASS REINFORCED FELT LINER OR UV GRP)		18.0
SP75508003	SP75508004	SL75508002	DIP	48	192	0.08%	INSTALL CIPP (FIBERGLASS REINFORCED FELT LINER OR UV GRP)		16.5
SP75508004	SP75508005	SL75508003	RCP	48	243	0.07%	INSTALL CIPP (FIBERGLASS REINFORCED FELT LINER OR UV GRP)		16.5
SP75508005	SP75508006	SL75508004	RCP	48	569	0.04%	INSTALL CIPP (FIBERGLASS REINFORCED FELT LINER OR UV GRP)		16.5
SP75508006	SP76505001	SL75508005	RCP	48	290	0.13%	INSTALL CIPP (FIBERGLASS REINFORCED FELT LINER OR UV GRP)		16.5

CRABTREE CREEK CONNECTOR SEWERS

UPSTREAM MANHOLE	DOWNSTREAM MANHOLE	LINE ID NUMBER	PIPE MATERIAL	APPROX PIPE DIAMETER (INCHES)	APPROX LENGTH (FEET)	APPROX SLOPE (%)	PROPOSED REHABILITATION 1	PROPOSED REHABILITATION 2	CIPP THICKNESS (MM)
SP75511046	SP75511023	SL75511049	PVC	8	27	NOT AVAIL	CLEAN AND TELEWISE SEWER; SUBMIT FOR REVIEW	TO BE DETERMINED FROM VIDEO REVIEW	TBD
SP75512015	SP75512014	SL75512011	PVC	8	144	NOT AVAIL	CLEAN AND TELEWISE SEWER; SUBMIT FOR REVIEW	TO BE DETERMINED FROM VIDEO REVIEW	TBD
SP75508008	SP75508009	SL75508011	DIP	8	101	NOT AVAIL	CLEAN AND TELEWISE SEWER; SUBMIT FOR REVIEW	TO BE DETERMINED FROM VIDEO REVIEW	TBD
SP75508009	SP75508010	SL75508012	DIP	8	93	NOT AVAIL	CLEAN AND TELEWISE SEWER; SUBMIT FOR REVIEW	TO BE DETERMINED FROM VIDEO REVIEW	TBD
SP75508010	SP75508006	SL75508009	DIP	8	35	NOT AVAIL	CLEAN AND TELEWISE SEWER; SUBMIT FOR REVIEW	TO BE DETERMINED FROM VIDEO REVIEW	TBD

CRABTREE CREEK MANHOLES

MANHOLE ID	WALL MATERIAL	APPROX MH DIAMETER (FT)	APPROX DEPTH (FT)	RIM ELEV	GROUND ELEV	INVERT ELEV	EFFECTIVE 100 YEAR FLOOD ELEV	PROPOSED REHABILITATION 1	PROPOSED REHABILITATION 2	PROPOSED REHABILITATION 3
SP75511023	PRECAST	8	10.00	283.91			282.9	MODIFY MANHOLE PER DETAIL D ON SHEET D-4		COAT MANHOLE WITH CEMENTITIOUS MORTAR
SP75511011	PRECAST	6	6.55	278.63	278.15	272.08	282.6	INSTALL RISER AND FLAT-TOP; SEE DETAIL E ON SHEET D-4; SEE NOTES 8 AND 9		
SP75511019	PRECAST	6	6.20	277.78	277.10	271.58	282.6	INSTALL RISER AND FLAT-TOP; SEE DETAIL E ON SHEET D-4; SEE NOTES 8 AND 9	INSTALL VENT ON VENT STUB-OUT IN FLAT-TOP; VENT OPENING ELEVATION SHALL BE 285 OR A MIN OF 2 FEET HIGHER THAN FINAL RIM ELEVATION, WHICHEVER IS HIGHER; SEE NOTE 11	
SP75512014	PRECAST	5	7.89	279.05	278.37	271.16	282.6	INSTALL FLAT-TOP; SEE DETAIL E ON SHEET D-4		COAT MANHOLE WITH CEMENTITIOUS MORTAR
SP75512012	PRECAST	6	7.83	278.91	277.74	271.08	282.6	INSTALL FLAT-TOP; SEE DETAIL E ON SHEET D-4	REMOVE EXISTING VENT AND PLUG HOLE WITH CONCRETE	COAT MANHOLE WITH CEMENTITIOUS MORTAR
SP75512011	PRECAST	6	9.05	280.05	279.45	271.00	282.6	INSTALL FLAT-TOP; SEE DETAIL E ON SHEET D-4	INSTALL VENT ON VENT STUB-OUT IN FLAT-TOP; VENT OPENING ELEVATION SHALL BE 285 OR A MIN OF 2 FEET HIGHER THAN FINAL RIM ELEVATION, WHICHEVER IS HIGHER; SEE NOTE 11	COAT MANHOLE WITH CEMENTITIOUS MORTAR
SP75508003	PRECAST	6	7.68	278.55	277.56	270.87	282.6	INSTALL FLAT-TOP; SEE DETAIL E ON SHEET D-4		COAT MANHOLE WITH CEMENTITIOUS MORTAR
SP75508004	PRECAST	6	13.08	283.80	283.16	270.72	282.6	INSTALL FLAT-TOP; SEE DETAIL E ON SHEET D-4	REMOVE EXISTING VENT AND PLUG HOLE WITH CONCRETE	COAT MANHOLE WITH CEMENTITIOUS MORTAR
SP75508005	PRECAST	6	10.26	280.80	280.35	270.54	282.6	INSTALL FLAT-TOP; SEE DETAIL E ON SHEET D-4	INSTALL VENT ON VENT STUB-OUT IN FLAT-TOP; VENT OPENING ELEVATION SHALL BE 285 OR A MIN OF 2 FEET HIGHER THAN FINAL RIM ELEVATION, WHICHEVER IS HIGHER; SEE NOTE 11	COAT MANHOLE WITH CEMENTITIOUS MORTAR
SP75508006	PRECAST	6	8.84	279.15	278.99	270.31	282.6	INSTALL RISER AND FLAT-TOP; SEE DETAIL E ON SHEET D-4; SEE NOTE 9		COAT MANHOLE WITH CEMENTITIOUS MORTAR

CRABTREE CREEK CONNECTOR MANHOLES

MANHOLE ID	WALL MATERIAL	APPROX MH DIAMETER (FT)	APPROX DEPTH (FT)	RIM ELEV	GROUND ELEV	INVERT ELEV	EFFECTIVE 100 YEAR FLOOD ELEV	PROPOSED REHABILITATION 1	PROPOSED REHABILITATION 2	PROPOSED REHABILITATION 3
SP75511046										
SP75512015				7.78	288.84	287.07	281.06			
SP75508008										
SP75508009				4.72	279.87	278.56	275.15			
SP75508010				5.95	280.14	279.06	274.19			

SEE NOTE 3 FOR ALL CONNECTOR MANHOLES

LEGEND

	EXISTING GREENWAY
	PROPOSED GREENWAY (BY OTHERS)
	CREEK
	PROPERTY LINES

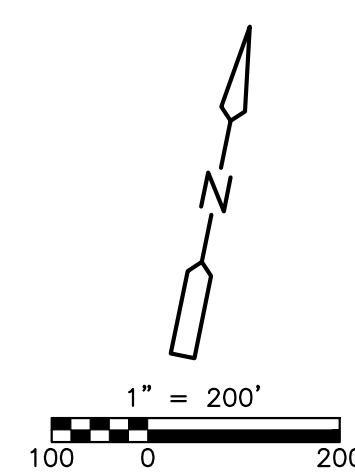

REVISIONS CARY PROJECT No.: SW3501 PROJECT No.: TOC-010 DESIGNED BY: DRAWN BY: A. SPIROU CHECKED BY: M. COLANGELO APPROVED BY: M. LAMBERT DATE: MARCH 2021			TOWN OF CARY CARY, NORTH CAROLINA	SHEET No. C-3
			FY 20-21 SEWER REHABILITATION PROJECT CRABTREE CREEK INTERCEPTOR	

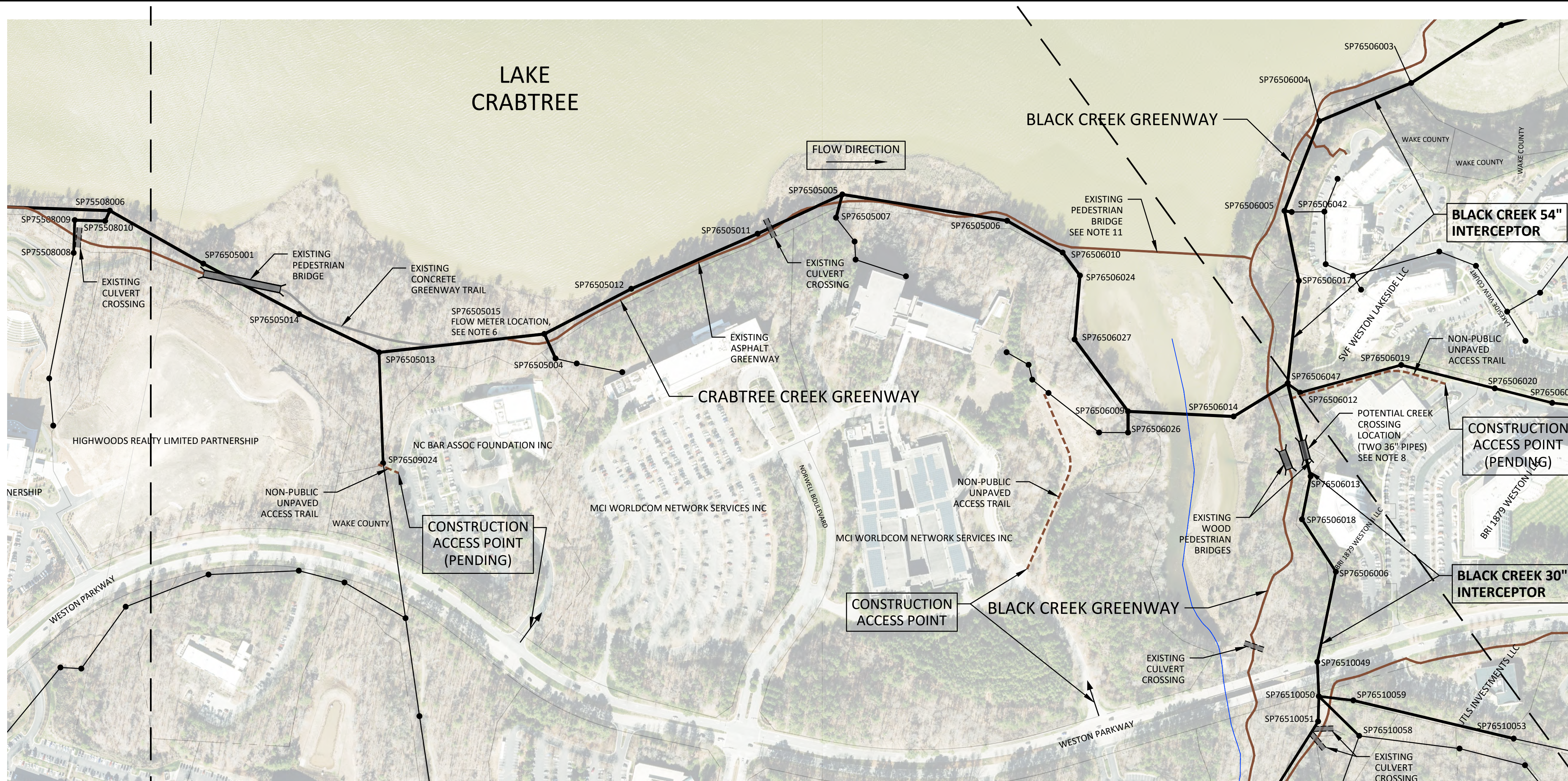

- NOTES:**
- ALL WORK MUST BE COMPLETED WITHIN THE EXISTING SEWER EASEMENT UNLESS APPROVED BY THE ENGINEER AND PROPERTY OWNER IN WRITING. EASEMENT WIDTHS VARY BUT CONTRACTOR SHOULD ASSUME THAT MOST EASEMENTS ARE 40 FEET WIDE UNLESS OTHERWISE SHOWN. PARTS OF THE EXISTING EASEMENT MAY NEED TO BE PREPARED IN ADVANCE OF THE WORK TO FACILITATE ACCESS. PREPARATION MAY INVOLVE STREAM BANK RESTORATION, GRADING, ETC. TO MAKE THE EASEMENT ACCESSIBLE FOR EQUIPMENT.
REFER TO THE STANDARD DETAILS ON SHEETS D-1 THROUGH D-5 WHETHER SPECIFICALLY REFERENCED OR NOT. REFER TO THE OWNER'S STANDARD SPECIFICATIONS AND DETAILS WHETHER SPECIFICALLY REFERENCED OR NOT.
 - SOME TREE LIMBS MAY NEED TO BE TRIMMED FOR ACCESS AT THE CONTRACTOR'S EXPENSE. COORDINATE WITH THE ENGINEER IN THE FIELD. ANY SIGNIFICANT TREE LIMBS THAT ARE DAMAGED THAT WERE NOT PREVIOUSLY TRIMMED OR THAT WERE NOT TRIMMED ENOUGH SHALL BE REMOVED BY THE CONTRACTOR.
 - MANHOLE INSPECTIONS ARE INCOMPLETE IN THIS AREA. ADDITIONAL MANHOLE REHABILITATION MAY BE ADDED IN THE FIELD BY THE ENGINEER.
 - SEE SHEET C-7 FOR ADDITIONAL GREENWAY INFORMATION.
 - CONSTRUCTION ACCESS POINTS ARE SHOWN UTILIZING EXISTING GREENWAY TRAILS WHERE APPLICABLE. IF THE GREENWAY TRAIL IS NOT SPECIFICALLY SHOWN AS AN ACCESS POINT, IT CANNOT BE USED FOR ACCESS FOR CONSTRUCTION EQUIPMENT. ANY DAMAGE TO THE GREENWAY TRAILS SHALL BE REPAIRED TO MATCH THE PRE-EXISTING CONDITIONS AT THE CONTRACTOR'S EXPENSE.
 - FLOW METER IS INSTALLED IN MH-SP76505015. PROVIDE 30 DAYS NOTICE TO THE ENGINEER BEFORE ANY ACTIVITY AT THIS MANHOLE (INCLUDING CLEANING THE SEWER, CIPP INSTALLATION, MANHOLE REHABILITATION, ETC.) SO THAT THE FLOW METER CAN BE REMOVED. FLOW DATA FROM THIS FLOW METER INDICATES AN AVERAGE FLOW OF APPROXIMATELY 4.3 MGD AND A PEAK FLOW OF APPROXIMATELY 23.1 MGD. THIS DATA IS PROVIDED AS GENERAL INFORMATION ONLY. THE BY-PASS PUMPING SYSTEM SHALL BE SIZED ACCORDING TO THE SPECIFICATIONS.
 - THE FINAL FLAT-TOP ELEVATION FOR SP76505005 SHALL BE A MINIMUM OF 2 FEET ABOVE THE HIGHEST GROUND ELEVATION AT THE MANHOLE. IT IS THE CONTRACTOR'S RESPONSIBILITY TO INVESTIGATE/MEASURE THE EXISTING MANHOLES SO THAT THE CORRECT RISER SECTIONS ARE INSTALLED TO MEET THIS REQUIREMENT WITHOUT THE INSTALLATION OF CONCRETE "DOUGHNUTS". IT IS ACCEPTABLE TO BE HIGHER THAN 2 FEET ABOVE GRADE BY USING RISER SECTIONS ONLY BUT THE HEIGHT ABOVE 2 FEET ABOVE GRADE SHALL BE MINIMIZED TO THE EXTENT POSSIBLE.
 - GREENWAY BRIDGE SHALL BE REMOVED AND NOT REPLACED BY CONTRACTOR AT NO ADDITIONAL COST. THIS IS ALSO A POTENTIAL LOCATION FOR A TEMPORARY STREAM CROSSING. SEE DETAIL 04000.11 ON SHEET D-1.
 - WHERE MANHOLE FLAT-TOPS OR CONES ARE REMOVED TEMPORARILY FOR CLEANING, CIPP INSTALLATION, OR OTHER ACCESS REASONS, TEMPORARY SECURITY MEASURES SHALL BE INSTALLED TO PREVENT PEDESTRIAN ACCESS IF LEFT UNATTENDED. CONTRACTOR SHALL PROVIDE A SUBMITTAL DETAILING THE TEMPORARY SECURITY MEASURES. NO MANHOLE FLAT-TOPS OR CONES AT MANHOLES THAT ARE DEEMED TO BE SUSCEPTIBLE TO FLOODING BY THE ENGINEER MAY BE REMOVED FOR TEMPORARY ACCESS UNLESS OTHERWISE APPROVED.
 - CONTRACTOR SHALL PROVIDE SURVEYING SERVICES AS NECESSARY TO ENSURE THAT THE VENT OPENING IS PLACED AT THE CORRECT ELEVATION.
 - PUBLIC ACCESS TO THE EXISTING GREENWAY PEDESTRIAN BRIDGE SHALL BE MAINTAINED AT ALL TIMES. IT WILL BE ACCEPTABLE TO CLOSE THE WESTERN SIDE OF THE PEDESTRIAN BRIDGE WHEN NECESSITATED BY WORK IN THE AREA BUT THE EASTERN SIDE OF THE PEDESTRIAN BRIDGE SHALL REMAIN OPEN AT ALL TIMES. WHEN THE WESTERN SIDE OF THE PEDESTRIAN BRIDGE IS CLOSED, A SIGN SHALL BE INSTALLED ON THE EASTERN SIDE OF THE PEDESTRIAN BRIDGE INDICATING THAT THE BRIDGE IS CLOSED AHEAD. SEE SHEET C-7 FOR ADDITIONAL INFORMATION.

LEGEND

- EXISTING GREENWAY
- PROPOSED GREENWAY (BY OTHERS)
- CREEK
- PROPERTY LINES

SEE SHEET C-3

SEE SHEET C-5

CRABTREE CREEK INTERCEPTOR

UPSTREAM MANHOLE	DOWNSTREAM MANHOLE	LINE ID NUMBER	PIPE MATERIAL	APPROX PIPE DIAMETER (INCHES)	APPROX LENGTH (FEET)	APPROX SLOPE (%)	PROPOSED REHABILITATION 1	PROPOSED REHABILITATION 2	CIPP THICKNESS FOR FIBERGLASS REINFORCED FELT (MM)
SP76505001	SP76505014	SL76505004	RCP	48	313	-0.02%	INSTALL CIPP (FIBERGLASS REINFORCED FELT LINER OR UV GRP)		18.0
SP76505014	SP76505013	SL76505003	RCP	48	320	0.13%	INSTALL CIPP (FIBERGLASS REINFORCED FELT LINER OR UV GRP)		16.5
SP76505013	SP76505015	SL76505008	RCP	48	504	0.02%	INSTALL CIPP (FIBERGLASS REINFORCED FELT LINER OR UV GRP)		16.5
SP76505015	SP76505012	SL76505001	RCP	48	256	0.00%	INSTALL CIPP (FIBERGLASS REINFORCED FELT LINER OR UV GRP)		18.0
SP76505012	SP76505011	SL76505014	RCP	48	422	0.04%	INSTALL CIPP (FIBERGLASS REINFORCED FELT LINER OR UV GRP)		16.5
SP76505011	SP76505005	SL76505015	RCP	48	331	-0.02%	INSTALL CIPP (FIBERGLASS REINFORCED FELT LINER OR UV GRP)		18.0
SP76505005	SP76505006	SL76505009	RCP	48	514	0.03%	INSTALL CIPP (FIBERGLASS REINFORCED FELT LINER OR UV GRP)		16.5
SP76505006	SP76506010	SL76506028	RCP	48	193	0.20%	INSTALL CIPP (FIBERGLASS REINFORCED FELT LINER OR UV GRP)		18.0
SP76506010	SP76506024	SL76506026	RCP	48	87	-0.05%	INSTALL CIPP (FIBERGLASS REINFORCED FELT LINER OR UV GRP)		18.0
SP76506024	SP76506027	SL76506027	RCP	48	194	0.09%	INSTALL CIPP (FIBERGLASS REINFORCED FELT LINER OR UV GRP)		18.0
SP76506027	SP76506009	SL76506018	RCP	48	268	0.11%	INSTALL CIPP (FIBERGLASS REINFORCED FELT LINER OR UV GRP)		18.0
SP76506009	SP76506014	SL76506020	DIP	48	319	0.13%	INSTALL CIPP (FIBERGLASS REINFORCED FELT LINER OR UV GRP)		18.0
SP76506014	SP76506047	SL76506023	RCP	48	188	0.46%	INSTALL CIPP (FIBERGLASS REINFORCED FELT LINER OR UV GRP)		21.0

CRABTREE CREEK CONNECTOR SEWERS

UPSTREAM MANHOLE	DOWNSTREAM MANHOLE	LINE ID NUMBER	PIPE MATERIAL	APPROX PIPE DIAMETER (INCHES)	APPROX LENGTH (FEET)	APPROX SLOPE (%)	PROPOSED REHABILITATION 1	PROPOSED REHABILITATION 2	CIPP THICKNESS (MM)
SP76509024	SP76505013	SL76509053	PVC	8	340	NOT AVAILABLE	CLEAN AND TELEVISION SEWER; SUBMIT FOR REVIEW	TO BE DETERMINED FROM VIDEO REVIEW	TBD
SP76505004	SP76505015	SL76505005	PVC	8	82	NOT AVAILABLE	CLEAN AND TELEVISION SEWER; SUBMIT FOR REVIEW	TO BE DETERMINED FROM VIDEO REVIEW	TBD
SP76505007	SP76505005	SL76505012	DIP	8	74	NOT AVAILABLE	CLEAN AND TELEVISION SEWER; SUBMIT FOR REVIEW	TO BE DETERMINED FROM VIDEO REVIEW	TBD
SP76506026	SP76506009	SL76506017	DIP	8	65	NOT AVAILABLE	CLEAN AND TELEVISION SEWER; SUBMIT FOR REVIEW	TO BE DETERMINED FROM VIDEO REVIEW	TBD

CRABTREE CREEK MANHOLES

MANHOLE ID	WALL MATERIAL	APPROX MH DIAMETER (FT)	APPROX DEPTH (FT)	RIM ELEV	GROUND ELEV	INVERT ELEV	EFFECTIVE 100 YEAR FLOOD ELEV	PROPOSED REHABILITATION 1	PROPOSED REHABILITATION 2	PROPOSED REHABILITATION 3
SP76505001	PRECAST	4	10.28	280.22	279.73	269.94	282.6	INSTALL FLAT-TOP; SEE DETAIL E ON SHEET D-4		COAT MANHOLE WITH CEMENTITIOUS MORTAR
SP76505014	PRECAST	5	12.73	282.73	279.13	270.00	282.6	INSTALL FLAT-TOP; SEE DETAIL E ON SHEET D-4		COAT MANHOLE WITH CEMENTITIOUS MORTAR
SP76505013	PRECAST	6	15.29	284.89	280.89	269.60	282.6	INSTALL FLAT-TOP; SEE DETAIL E ON SHEET D-4	INSTALL VENT ON VENT STUB-OUT IN FLAT-TOP; VENT OPENING ELEVATION SHALL BE 285 OR A MIN OF 2 FEET HIGHER THAN FINAL RIM ELEVATION, WHICHEVER IS HIGHER. SEE NOTE 10	COAT MANHOLE WITH CEMENTITIOUS MORTAR
SP76505015	PRECAST	6	10.94	280.42	278.08	269.48	282.6	INSTALL FLAT-TOP; SEE DETAIL E ON SHEET D-4		COAT MANHOLE WITH CEMENTITIOUS MORTAR
SP76505012	PRECAST	6	7.86	277.14	277.00	269.48	282.6	INSTALL FLAT-TOP; SEE DETAIL E ON SHEET D-4		COAT MANHOLE WITH CEMENTITIOUS MORTAR
SP76505011	PRECAST	6	15.41	284.74	282.51	269.33	282.6	INSTALL FLAT-TOP; SEE DETAIL E ON SHEET D-4	INSTALL VENT ON VENT STUB-OUT IN FLAT-TOP; VENT OPENING ELEVATION SHALL BE 285 OR A MIN OF 2 FEET HIGHER THAN FINAL RIM ELEVATION, WHICHEVER IS HIGHER. SEE NOTE 10	COAT MANHOLE WITH CEMENTITIOUS MORTAR
SP76505006	PRECAST	6	13.93	283.32	281.71	269.39	282.6	INSTALL RISER AND FLAT-TOP; SEE DETAIL E ON SHEET D-4; SEE NOTE 7		COAT MANHOLE WITH CEMENTITIOUS MORTAR
SP76505008	PRECAST	6	10.50	279.74	279.69	269.24	282.6	INSTALL FLAT-TOP; SEE DETAIL E ON SHEET D-4		COAT MANHOLE WITH CEMENTITIOUS MORTAR
SP76506010	PRECAST	6	14.44	283.29	282.33	268.85	282.6	INSTALL WATERTIGHT FRAME AND COVER (TYPE 2A)		COAT MANHOLE WITH CEMENTITIOUS MORTAR
SP76506024	PRECAST	6	14.38	283.27	282.02	268.69	282.6	INSTALL FLAT-TOP; SEE DETAIL E ON SHEET D-4	INSTALL VENT ON VENT STUB-OUT IN FLAT-TOP; VENT OPENING ELEVATION SHALL BE 285 OR A MIN OF 2 FEET HIGHER THAN FINAL RIM ELEVATION, WHICHEVER IS HIGHER. SEE NOTE 10	COAT MANHOLE WITH CEMENTITIOUS MORTAR
SP76506009	PRECAST	4	15.49	283.91	281.06	268.42	282.6	INSTALL WATERTIGHT FRAME AND COVER (TYPE 2A)		COAT MANHOLE WITH CEMENTITIOUS MORTAR
SP76506014	CEMENTITIOUS	4	11.75	279.74	275.99	267.99	282.6	INSTALL WATERTIGHT FRAME AND COVER (TYPE 2A)		SEAL LEAKS AS DIRECTED BY ENGINEER IN THE FIELD

CRABTREE CREEK CONNECTOR MANHOLES

MANHOLE ID	WALL MATERIAL	APPROX MH DIAMETER (FT)	APPROX DEPTH (FT)	RIM ELEV	GROUND ELEV	INVERT ELEV	EFFECTIVE 100 YEAR FLOOD ELEV	PROPOSED REHABILITATION 1	PROPOSED REHABILITATION 2	PROPOSED REHABILITATION 3
SP76509024			8.44	287.98	287.48	278.52				
SP76505004			15.21	285.55	283.77	280.34				
SP76505007			9.27	287.82	286.78	278.55				
SP76506026			21.48	307.23	305.66	285.75				

SEE NOTE 3 FOR ALL CONNECTOR MANHOLES

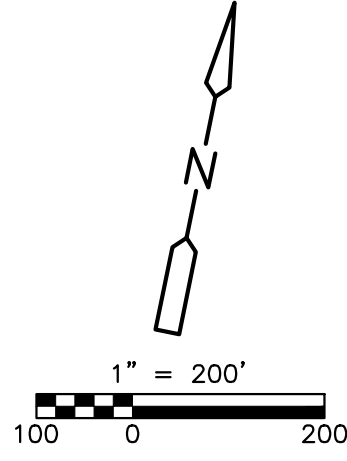

REVISIONS 	CARY PROJECT No.: SW3501			TOWN OF CARY CARY, NORTH CAROLINA	SHEET No. C-4
	PROJECT No.: TOC-010			FY 20-21 SEWER REHABILITATION PROJECT CRABTREE CREEK INTERCEPTOR	
	DESIGNED BY:				
	DRAWN BY: A. SPIROU				
	CHECKED BY: M. COLANGELO				
APPROVED BY: M. LAMBERT	6592 Bob White Trail Stanley, NC 28164 Office 704.822.8444 Fax 704.822.8666				
DATE: MARCH 2021					

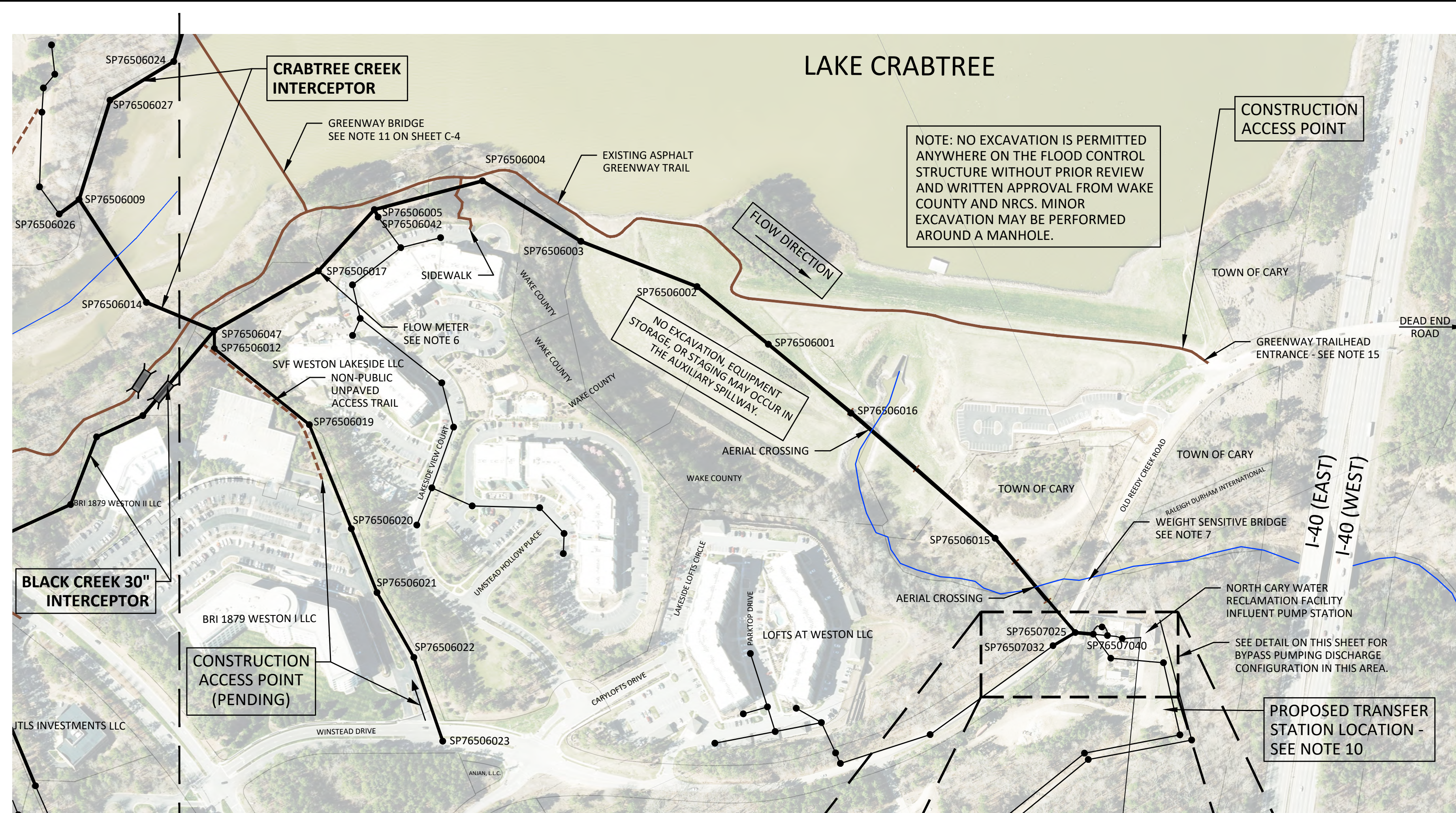

- NOTES:**
- ALL WORK MUST BE COMPLETED WITHIN THE EXISTING SEWER EASEMENT UNLESS APPROVED BY THE ENGINEER AND PROPERTY OWNER IN WRITING. EASEMENT WIDTHS VARY BUT CONTRACTOR SHOULD ASSUME THAT MOST EASEMENTS ARE 40 FEET WIDE UNLESS OTHERWISE SHOWN. PARTS OF THE EXISTING EASEMENT MAY NEED TO BE PREPARED IN ADVANCE OF THE WORK TO FACILITATE ACCESS. PREPARATION MAY INVOLVE STREAM BANK RESTORATION, GRADING, ETC. TO MAKE THE EASEMENT ACCESSIBLE FOR EQUIPMENT.
 - REFER TO THE STANDARD DETAILS ON SHEETS D-1 THROUGH D-5 WHETHER SPECIFICALLY REFERENCED OR NOT. REFER TO THE OWNER'S STANDARD SPECIFICATIONS AND DETAILS WHETHER SPECIFICALLY REFERENCED OR NOT.
 - SOME TREE LIMBS MAY NEED TO BE TRIMMED FOR ACCESS AT THE CONTRACTOR'S EXPENSE. COORDINATE WITH THE ENGINEER IN THE FIELD. ANY SIGNIFICANT TREE LIMBS THAT ARE DAMAGED THAT WERE NOT PREVIOUSLY TRIMMED OR THAT WERE NOT TRIMMED ENOUGH SHALL BE REMOVED BY THE CONTRACTOR.
 - MANHOLE INSPECTIONS ARE INCOMPLETE IN THIS AREA. ADDITIONAL MANHOLE REHABILITATION MAY BE ADDED IN THE FIELD BY THE ENGINEER.
 - SEE SHEET C-7 FOR ADDITIONAL GREENWAY INFORMATION.
 - CONSTRUCTION ACCESS POINTS ARE SHOWN UTILIZING EXISTING GREENWAY TRAILS WHERE APPLICABLE. IF THE GREENWAY TRAIL IS NOT SPECIFICALLY SHOWN AS AN ACCESS POINT, IT CANNOT BE USED FOR CONSTRUCTION EQUIPMENT. ANY DAMAGE TO THE GREENWAY TRAILS SHALL BE REPAIRED TO MATCH THE PRE-EXISTING CONDITIONS AT THE CONTRACTOR'S EXPENSE.
 - FLOW METER IS INSTALLED IN MH-SP76506017. PROVIDE 30 DAYS NOTICE TO THE ENGINEER BEFORE ANY ACTIVITY AT THIS MANHOLE (INCLUDING CLEANING THE SEWER, CIPP INSTALLATION, MANHOLE REHABILITATION, ETC.) SO THAT THE FLOW METER CAN BE REMOVED. FLOW DATA FROM THIS FLOW METER INDICATES AN AVERAGE FLOW OF APPROXIMATELY 5.4 MGD AND A PEAK FLOW OF APPROXIMATELY 45.5 MGD. THIS DATA IS PROVIDED AS GENERAL INFORMATION ONLY. THE BY-PASS PUMPING SYSTEM SHALL BE SIZED ACCORDING TO THE SPECIFICATIONS.
 - THE BRIDGE ON OLD REEDY CREEK ROAD HAS A WEIGHT LIMIT OF 32 TONS FOR A SINGLE AXLE VEHICLE AND 38 TONS FOR A TANDEM AXLE VEHICLE. CONTRACTOR SHALL ADHERE TO ALL POSTED WEIGHT LIMITS.
 - NO EXCAVATION TO ADDRESS A DEFECTIVE LINER WILL BE POSSIBLE FROM SP76506003 TO SP76506015 DUE TO THE LAKE CRABTREE DAM. THEREFORE, CLOSED CIRCUIT TELEVISION INSPECTION OF THE LINER AFTER PULLED IN BUT PRIOR TO COMMENCING THE CURING PROCESS WILL BE OF THE UTMOST IMPORTANCE.
 - FOR THE SEWERS FROM SP76506003 TO SP76506002 AND SP76506002 TO SP76506001, THE SOIL MODULUS CAN BE 1,500 PSI WHEN CALCULATING UV GRP CIPP LINER THICKNESS. ALL OTHER SEWER SECTIONS WILL HAVE A SOIL MODULUS OF 1,000 PSI WHEN CALCULATING UV GRP CIPP LINER THICKNESS AS INDICATED IN SPECIFICATION 02651A - CIPP FOR MAIN SEWERS - UV CURED.
 - THE TRANSFER STATION FOR HOLDING SOLIDS REMOVED FROM THE SEWER DURING CLEANING OPERATIONS MAY BE LOCATED IN THIS AREA. COORDINATE WITH THE ENGINEER IN THE FIELD TO DETERMINE THE FINAL LOCATION. SEE SPECIFICATION 02650 - SEWER CLEANING AND TELEVISION INSPECTION AND DETAIL F ON SHEET D-4 FOR MORE INFORMATION.
 - SP76506047 IS LINED WITH CEMENTITIOUS MORTAR. CAREFULLY CUT THROUGH THE CEMENTITIOUS MORTAR APPROXIMATELY 3 INCHES BELOW THE JOINT WHERE THE EXISTING RISER OR FLAT-TOP WILL BE REMOVED AND REPLACED. AFTER THE NEW RISER AND/OR FLAT-TOP HAVE BEEN INSTALLED, APPLY NON-SHRINK GROUT TO JOINT BETWEEN THE EXISTING RISER AND NEW RISER OR FLAT-TOP.
 - PIPE DIAMETERS ARE BASED ON INCOMPLETE INFORMATION AND MAY NOT BE ACCURATE FOR SP76507025 TO SP76507040 AND SP76507040 TO BARSCREEN. CONTRACTOR TO VERIFY.
 - SP76506016 MAY NEED FURTHER INVESTIGATION AFTER THE MANHOLE HAS BEEN COATED WITH CEMENTITIOUS MORTAR. COORDINATE WITH THE ENGINEER IN THE FIELD TO DETERMINE ADDITIONAL ACTIVITIES THAT MAY BE PERFORMED AT THIS MANHOLE AT A COST TO BE DETERMINED AFTER THE ADDITIONAL ACTIVITIES ARE DEFINED. ADDITIONAL ACTIVITIES MAY OR MAY NOT INCLUDE EXISTING BID ITEMS. BID ITEM PRICES WILL BE USED WHERE APPROPRIATE.
 - THE FINAL FLAT-TOP ELEVATION FOR THESE MANHOLES SHALL BE A MINIMUM OF 2 FEET ABOVE THE HIGHEST GROUND ELEVATION AT THE MANHOLE. IT IS THE CONTRACTOR'S RESPONSIBILITY TO INVESTIGATE/MEASURE THE EXISTING MANHOLES SO THAT THE CORRECT RISER/FLAT-TOP SECTIONS ARE INSTALLED TO MEET THIS REQUIREMENT WITHOUT THE INSTALLATION OF CONCRETE "DOUGHNUTS". IT IS ACCEPTABLE TO BE HIGHER THAN 2 FEET ABOVE GRADE BY USING RISER/FLAT-TOP SECTIONS ONLY BUT THE HEIGHT ABOVE 2 FEET ABOVE GRADE SHALL BE MINIMIZED TO THE EXTENT POSSIBLE. COORDINATE WITH THE ENGINEER IN THE FIELD AS NECESSARY.
 - ACCESS THROUGH AN EXISTING GATE. CONTRACTOR RESPONSIBLE FOR SECURING THE GATE TO BLOCK ACCESS WHEN REQUIRED. SEE SHEET C-7.
 - WHERE MANHOLE FLAT-TOPS OR CONES ARE REMOVED TEMPORARILY FOR CLEANING, CIPP INSTALLATION, OR OTHER ACCESS REASONS, TEMPORARY SECURITY MEASURES SHALL BE INSTALLED TO PREVENT PEDESTRIAN ACCESS IF LEFT UNATTENDED. CONTRACTOR SHALL PROVIDE A SUBMITTAL DETAILING THE TEMPORARY SECURITY MEASURES. NO MANHOLE FLAT-TOPS OR CONES AT MANHOLES THAT ARE DEEMED TO BE SUSCEPTIBLE TO FLOODING BY THE ENGINEER MAY BE REMOVED FOR TEMPORARY ACCESS UNLESS OTHERWISE APPROVED.
 - CONTRACTOR SHALL PROVIDE SURVEYING SERVICES AS NECESSARY TO ENSURE THAT THE VENT OPENING IS PLACED AT THE CORRECT ELEVATION.
 - TENTATIVE UV GRP THICKNESSES ARE SHOWN. LINER THICKNESS FOR UV CURED GRP TO BE SUBMITTED BY CONTRACTOR AND APPROVED BY THE ENGINEER.
 - THE TAR SHALL BE REMOVED FROM MANHOLES PRIOR TO THE INSTALLATION OF CEMENTITIOUS MORTAR. SEE THE PAY ITEM DESCRIPTION FOR MANHOLE REHABILITATION FOR ADDITIONAL INFORMATION.

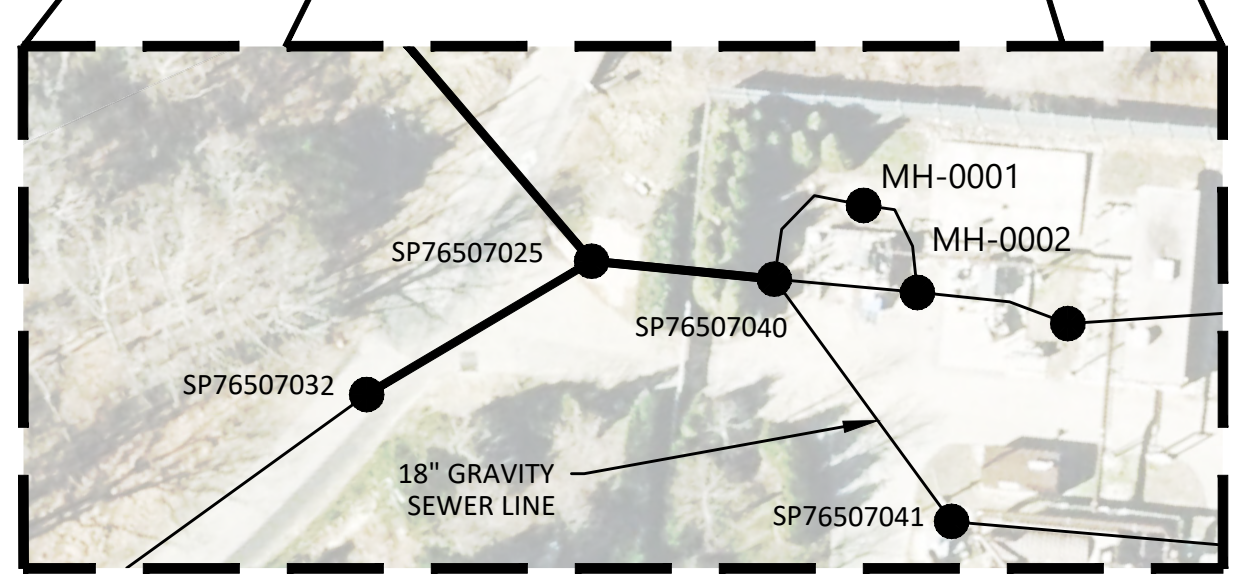
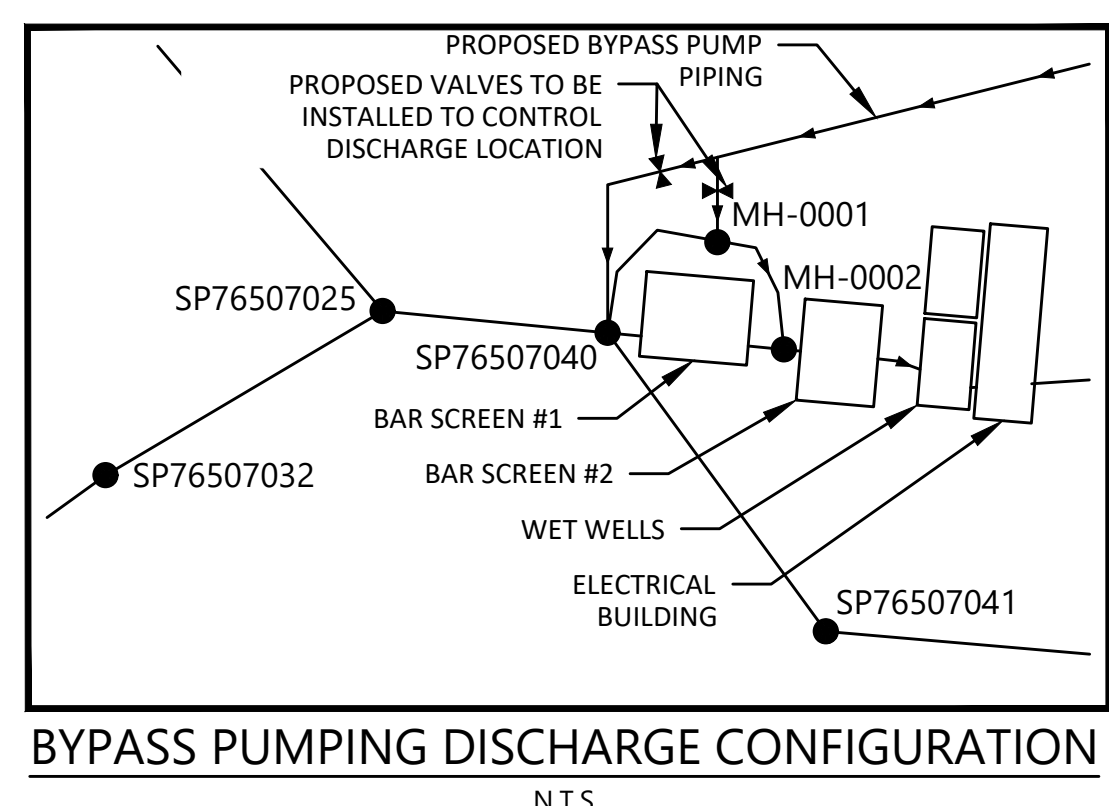

MANHOLE ID	WALL MATERIAL	APPROX MH DIAMETER (FT)	APPROX DEPTH (FT)	RIM ELEV	GROUND ELEV	INVERT ELEV	EFFECTIVE 100 YEAR FLOOD ELEV	PROPOSED REHABILITATION 1	PROPOSED REHABILITATION 2	PROPOSED REHABILITATION 3
SP76506047	CEMENTITIOUS	4 AND 10	31.97	299.10	295.37	267.13	282.6	INSTALL RISER AND/OR FLAT-TOP. SEE DETAIL E ON SHEET D-4 (EXCEPT A TYPE 3 36" FRAME COVER SHALL BE INSTALLED); SEE NOTES 11 AND 14	INSTALL VENT; VENT OPENING ELEVATION SHALL BE 285 OR A MIN OF 2 FEET HIGHER THAN FINAL RM ELEVATION, WHICHEVER IS HIGHER; SEE NOTE 17	SEAL LEAKS AS DIRECTED BY ENGINEER IN THE FIELD
SP76506017	PRECAST	4 AND 8	23.86	291.02	289.59	267.16	282.6			COAT MANHOLE WITH CEMENTITIOUS MORTAR
SP76506005	PRECAST-TAR	4 AND 8	26.65	293.54	290.13	266.89	282.6			COAT MANHOLE WITH CEMENTITIOUS MORTAR; SEE NOTE 19
SP76506004	PRECAST-TAR	4 AND 8	28.07	294.81	289.99	266.74	282.6	INSTALL RISER AND/OR FLAT-TOP. SEE DETAIL E ON SHEET D-4; SEE NOTE 14	INSTALL VENT; VENT OPENING ELEVATION SHALL BE 285 OR A MIN OF 2 FEET HIGHER THAN FINAL RM ELEVATION, WHICHEVER IS HIGHER; SEE NOTE 17	COAT MANHOLE WITH CEMENTITIOUS MORTAR; SEE NOTE 19
SP76506003	PRECAST-TAR	4 AND 8	14.24	280.78	277.31	266.54	282.6	INSTALL WATERTIGHT FRAME AND COVER (TYPE 2A)		COAT MANHOLE WITH CEMENTITIOUS MORTAR; SEE NOTE 19
SP76506002	PRECAST-TAR	4, 5, AND 8	48.00	314.32	310.65	266.32	282.6	INSTALL RISER AND/OR FLAT-TOP. SEE DETAIL E ON SHEET D-4; SEE NOTE 14	INSTALL VENT; VENT OPENING ELEVATION SHALL BE 285 OR A MIN OF 2 FEET HIGHER THAN FINAL RM ELEVATION, WHICHEVER IS HIGHER; SEE NOTE 17	COAT MANHOLE WITH CEMENTITIOUS MORTAR; SEE NOTE 19
SP76506001	PRECAST	4, 5, AND 8	43.93	310.17	307.00	266.24	282.6	INSTALL RISER AND/OR FLAT-TOP. SEE DETAIL E ON SHEET D-4; SEE NOTE 14	INSTALL VENT; VENT OPENING ELEVATION SHALL BE 285 OR A MIN OF 2 FEET HIGHER THAN FINAL RM ELEVATION, WHICHEVER IS HIGHER; SEE NOTE 17	COAT MANHOLE WITH CEMENTITIOUS MORTAR
SP76506016	PRECAST-TAR	8	13.75	279.85	274.76	266.10	282.6			COAT MANHOLE WITH CEMENTITIOUS MORTAR; SEE NOTES 13 AND 19
SP76507015	PRECAST	8	26.71	292.41	288.42	265.70	282.6	INSTALL RISER AND/OR FLAT-TOP. SEE DETAIL E ON SHEET D-4; SEE NOTE 14		COAT MANHOLE WITH CEMENTITIOUS MORTAR
SP76507025	PRECAST	8	14.25	279.51	279.25	265.26	282.6	INSTALL RISER AND/OR FLAT-TOP. SEE DETAIL E ON SHEET D-4; SEE NOTE 14	INSTALL VENT; VENT OPENING ELEVATION SHALL BE 285 OR A MIN OF 2 FEET HIGHER THAN FINAL RM ELEVATION, WHICHEVER IS HIGHER; SEE NOTE 17	COAT MANHOLE WITH CEMENTITIOUS MORTAR
SP76507040	PRECAST		15.38	278.40	276.00	263.02	282.6	INSTALL RISER AND/OR FLAT-TOP. SEE DETAIL E ON SHEET D-4; SEE NOTE 14		COAT MANHOLE WITH CEMENTITIOUS MORTAR

MANHOLE ID	WALL MATERIAL	APPROX MH DIAMETER (FT)	APPROX DEPTH (FT)	RIM ELEV	GROUND ELEV	INVERT ELEV	100 YEAR FLOOD ELEV	PROPOSED REHABILITATION 1	PROPOSED REHABILITATION 2	PROPOSED REHABILITATION 3
SP76506023										
SP76506022										
SP76506021										
SP76506020										
SP76506019										
SP76506012										
SP76506042										
SP76507032										

INFORMATION PRESENTLY NOT AVAILABLE

SEE NOTE 3 FOR ALL CONNECTOR MANHOLES

UPSTREAM MANHOLE	DOWNSTREAM MANHOLE	LINE ID NUMBER	PIPE MATERIAL	APPROX PIPE DIAMETER (INCHES)	APPROX LENGTH (FEET)	APPROX SLOPE (%)	PROPOSED REHABILITATION 1	PROPOSED REHABILITATION 2	CIPP THICKNESS FOR UV GRP (MM)
SP76506047	SP76506017	SL76506005	SPIROLITE	54	308	-0.01%	INSTALL UV GRP CIPP		15.0 - SEE NOTE 18
SP76506017	SP76506005	SL76506004	SPIROLITE	54	213	0.13%	INSTALL UV GRP CIPP		15.0 - SEE NOTE 18
SP76506005	SP76506004	SL76506014	SPIROLITE	54	290	0.05%	INSTALL UV GRP CIPP		15.0 - SEE NOTE 18
SP76506004	SP76506003	SL76506013	SPIROLITE	54	304	0.07%	INSTALL UV GRP CIPP		15.0 - SEE NOTE 18
SP76506003	SP76506002	SL76506012	DIP	54	321	0.07%	INSTALL UV GRP CIPP - SEE NOTES 8 AND 9		15.0 - SEE NOTE 18
SP76506002	SP76506001	SL76506001	DIP	54	236	0.03%	INSTALL UV GRP CIPP - SEE NOTES 8 AND 9		15.0 - SEE NOTE 18
SP76506001	SP76506016	SL76506011	DIP	54	274	0.05%	INSTALL UV GRP CIPP - SEE NOTE 8		15.0 - SEE NOTE 18
SP76506016	SP76507015	SL76506002	DIP	54	503	0.08%	INSTALL UV GRP CIPP - SEE NOTE 8		14.0 - SEE NOTE 18
SP76507015	SP76507025	SL76506043	DIP	54	320	0.14%	INSTALL UV GRP CIPP		14.0 - SEE NOTE 18
SP76507025	SP76507040	SL76507021	DIP	42	48	4.69%	INSTALL UV GRP CIPP; SEE NOTE 12		11.0 - SEE NOTE 18
SP76507040		BARSREEN		36	20		INSTALL UV GRP CIPP; SEE NOTE 12		11.0 - SEE NOTE 18

UPSTREAM MANHOLE	DOWNSTREAM MANHOLE	LINE ID NUMBER	PIPE MATERIAL	APPROX PIPE DIAMETER (INCHES)	APPROX SURVEYED LENGTH (FEET)	APPROX SLOPE (%)	PROPOSED REHABILITATION 1	PROPOSED REHABILITATION 2	CIPP THICKNESS (MM)
SP76506023	SP76506022	SL76506003	TRUSS	8	233	NOT AVAL	CLEAN AND TELEVISION SEWER; SUBMIT FOR REVIEW	TO BE DETERMINED FROM VIDEO REVIEW	TBD
SP76506022	SP76506021	SL76506010	TRUSS	8	197	NOT AVAL	CLEAN AND TELEVISION SEWER; SUBMIT FOR REVIEW	TO BE DETERMINED FROM VIDEO REVIEW	TBD
SP76506021	SP76506020	SL76506009	TRUSS	8	181	NOT AVAL	CLEAN AND TELEVISION SEWER; SUBMIT FOR REVIEW	TO BE DETERMINED FROM VIDEO REVIEW	TBD
SP76506020	SP76506019	SL76506008	TRUSS	8	296	NOT AVAL	CLEAN AND TELEVISION SEWER; SUBMIT FOR REVIEW	TO BE DETERMINED FROM VIDEO REVIEW	TBD
SP76506019	SP76506012	SL76506007	TRUSS	8	321	NOT AVAL	CLEAN AND TELEVISION SEWER; SUBMIT FOR REVIEW	TO BE DETERMINED FROM VIDEO REVIEW	TBD
SP76506012	SP76506047	SL76506048	PVC	8	48	NOT AVAL	CLEAN AND TELEVISION SEWER; SUBMIT FOR REVIEW	TO BE DETERMINED FROM VIDEO REVIEW	TBD
SP76506042	SP76506005	SL76506030	DIP	8	22	NOT AVAL	CLEAN AND TELEVISION SEWER; SUBMIT FOR REVIEW	TO BE DETERMINED FROM VIDEO REVIEW	TBD
SP76507032	SP76507025	SL76507036	DIP	8	68	NOT AVAL	CLEAN AND TELEVISION SEWER; SUBMIT FOR REVIEW	TO BE DETERMINED FROM VIDEO REVIEW	TBD

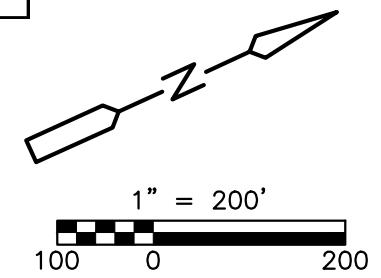

REVISIONS _____ _____ _____ _____ _____	CARY PROJECT No.: SW3501			TOWN OF CARY CARY, NORTH CAROLINA	SHEET No. C-5
	PROJECT No.: TOC-010			FY 20-21 SEWER REHABILITATION PROJECT	
	DESIGNED BY:			BLACK CREEK 54" INTERCEPTOR	
	DRAWN BY: A. SPIROU			6592 Bob White Trail Stanley, NC 28164 Office 704.822.8444 Fax 704.822.8666	
	CHECKED BY: M. COLANGELO			DATE: MARCH 2021	

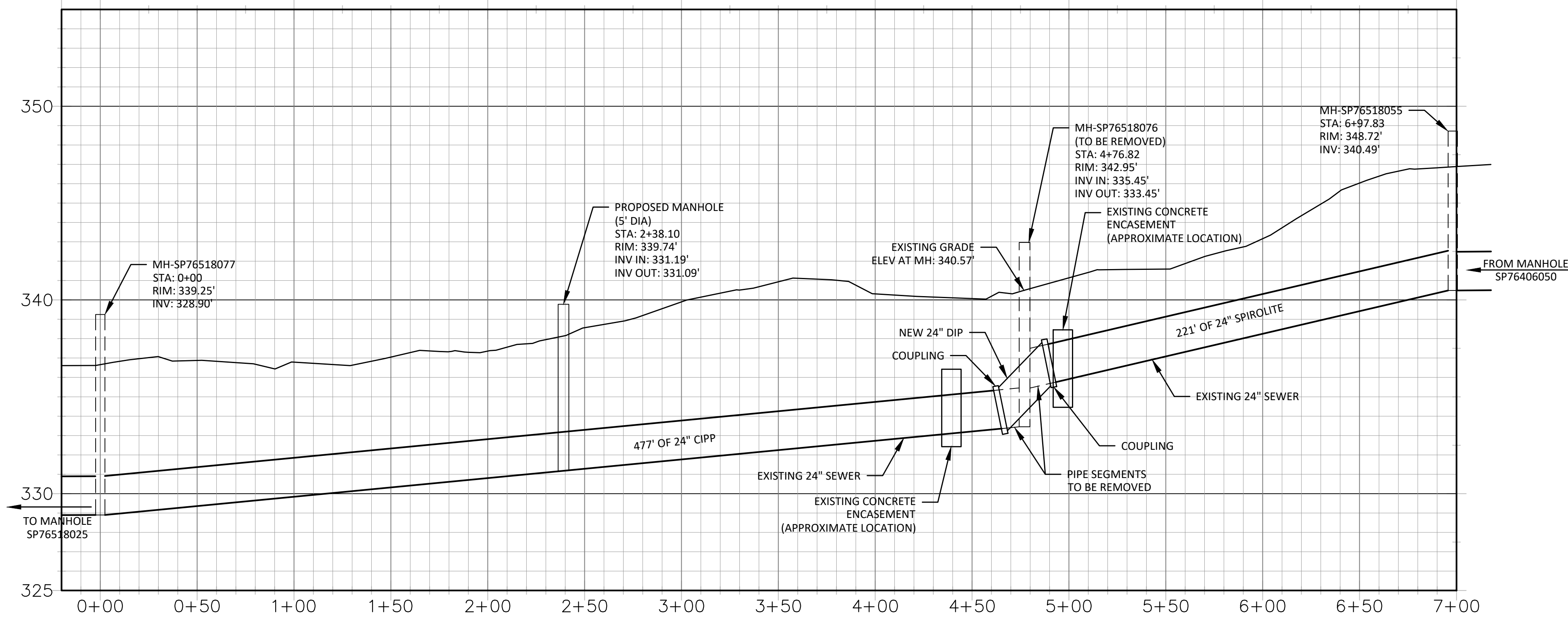

PROFILE

STEPS:

1. INSTALL NEW DOGHOUSE MANHOLE APPROXIMATELY 238 FEET DOWNSTREAM OF EXISTING MH-SP76518076. SEE COORDINATES FOR THE NEW MANHOLE IN THE PLAN VIEW ON THIS SHEET. SEE SHEET C-1 OF PLANS FOR MORE INFORMATION.
2. SET UP A TEMPORARY PUMP AROUND THE WORK AREA AT MH-SP76518076 PER DETAIL 04000.28 ON THIS SHEET. TO THE MAXIMUM EXTENT POSSIBLE, WORK AT MH-SP76518076 SHOULD BE PERFORMED DURING DRY-WEATHER WHEN BLACK CREEK IS GENERALLY LOW AND THE WEATHER FORECAST IS FAVORABLE WITH LITTLE TO MINIMAL RAIN. WHEN THE TEMPORARY PUMP AROUND IS INITIALLY INSTALLED, THE ENGINEER AND THE CONTRACTOR WILL REVIEW ON-SITE AND THE ENGINEER WILL DESIGNATE A CREEK ELEVATION THAT SHALL NOT BE EXCEEDED. IF AT ANY TIME FLOW DELIVERED VIA THE TEMPORARY PUMP AROUND IS INSUFFICIENT AND THE CREEK UPSTREAM OF THE TEMPORARY PUMP AROUND IS AT AN UNACCEPTABLE LEVEL AS DESIGNATED BY THE ENGINEER, THE CONTRACTOR MUST RESTORE NORMAL CREEK FLOW UNTIL SUCH TIME THAT THE CREEK FLOW CAN BE HANDLED APPROPRIATELY.
3. CAREFULLY REMOVE EXISTING MH-SP76518076 ENTIRELY. DISPOSE OF OFF-SITE.
4. THE OUTGOING SEWER AT MH-SP76518076 HAS PREVIOUSLY BEEN LINED WITH CIPP. REMOVE THE EXISTING SPIROLITE HOST PIPE FROM AROUND THE EXISTING CIPP EXPOSING AT LEAST 2 FEET OF CIPP. THE EDGE OF THE EXPOSED CIPP SHALL BE A MAXIMUM OF 6 FEET AWAY FROM THE EDGE OF MH-SP76518076.
5. FOR THE INCOMING SEWER, CUT THE CORRUGATED SECTIONS FROM THE EXTERIOR OF THE EXISTING SPIROLITE PIPE FOR THE FULL CIRCUMFERENCE OF THE PIPE LEAVING AS MUCH OF THE WALL THICKNESS AS POSSIBLE WHILE ALSO CREATING A SMOOTH EXTERIOR SURFACE FOR AT LEAST 2 FEET OF LENGTH. THE EDGE OF THE SPIROLITE PIPE SHALL BE A MAXIMUM OF 6 FEET AWAY FROM THE EDGE OF MH-SP76518076.
6. INSTALL NEW 24" DUCTILE IRON PIPE BETWEEN THE INCOMING SPIROLITE PIPE PREPARED IN STEP 5 AND EXPOSED OUTGOING CIPP PREPARED IN STEP 4. CONTRACTOR SHALL VERIFY THE LENGTH OF PIPE REQUIRED. THE 24" DUCTILE IRON PIPE AND THE INCOMING SPIROLITE PIPE PREPARED IN STEP 5 AND EXPOSED OUTGOING CIPP PREPARED IN STEP 4 SHALL BE CUT WITH BEVELED EDGES TO FACILITATE CONNECTIONS. CONNECT WITH A FERNCO COUPLING OR APPROVED EQUAL.
7. AS SOON AS POSSIBLE BUT NO LONGER THAN 24 HOURS AFTER COMPLETING THE REPAIR IN STEP 6, INSTALL TRANSITION LINER CIPP FROM MH-SP76518055 TO NEW MANHOLE INSTALLED IN STEP 1. THE CIPP THICKNESS FROM MH-SP76518055 TO THE DOWNSTREAM END OF THE REPAIR INSTALLED IN STEP 6 SHALL BE 12.0 MM. SEE TABLE ON SHEET C-1 OF THE PLANS. THE CIPP THICKNESS FROM THE DOWNSTREAM END OF THE REPAIR INSTALLED IN STEP 6 TO THE NEW MANHOLE INSTALLED IN STEP 1 SHALL BE 9.0 MM.

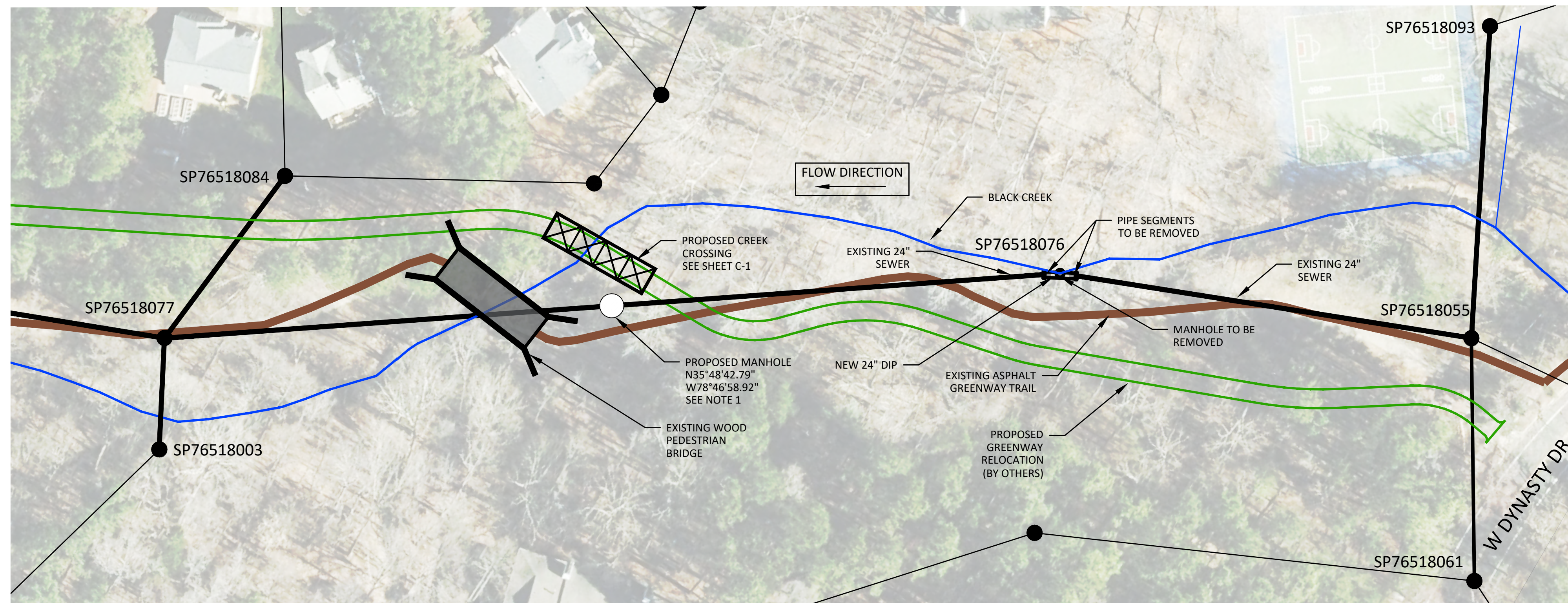

PLAN

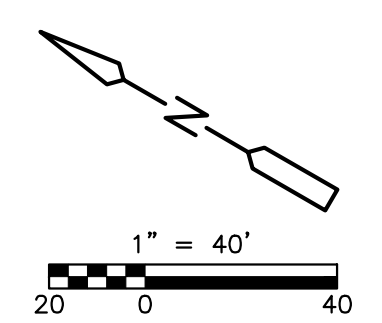
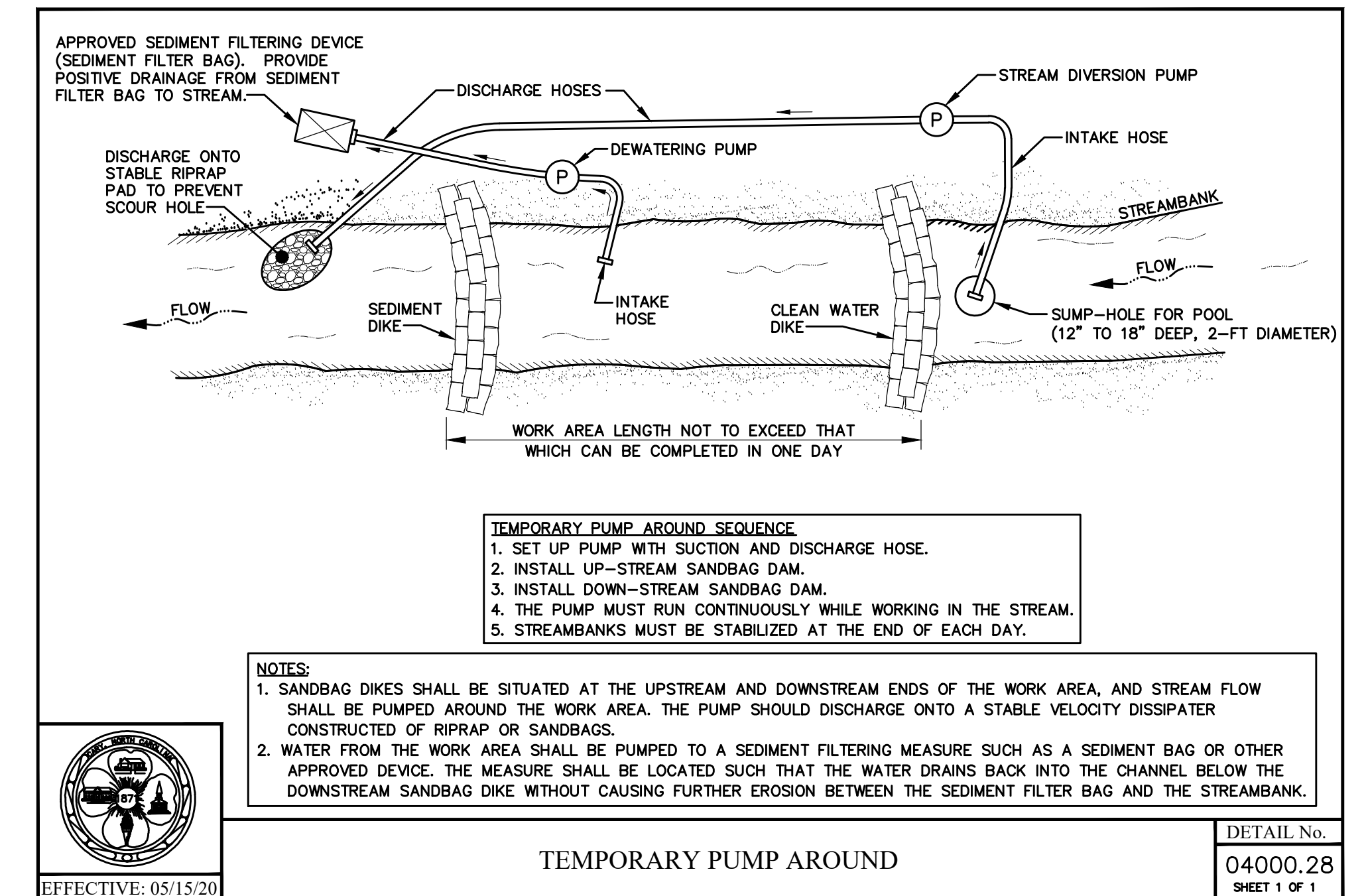

REVISIONS	CARY PROJECT No.: SW3501
	PROJECT No.: TOC-010
	DESIGNED BY:
	DRAWN BY: A. SPIROU
	CHECKED BY: M. COLANGELO
	APPROVED BY: M. LAMBERT
	DATE: MARCH 2021



TOWN OF CARY CARY, NORTH CAROLINA	SHEET No. C-6
FY 20-21 SEWER REHABILITATION PROJECT	
REPAIR AT MH-SP76518076	

CRABTREE CREEK INTERCEPTOR – SEE NOTE 4
(MH SP7511023 TO MH SP76506047)

BLACK CREEK 24"/30" INTERCEPTOR – SEE NOTE 5
(MH SP76518055 TO MH SP76506047)

BLACK CREEK 54" INTERCEPTOR – SEE NOTE 6
(MH SP76506047 TO MH SP76507040)

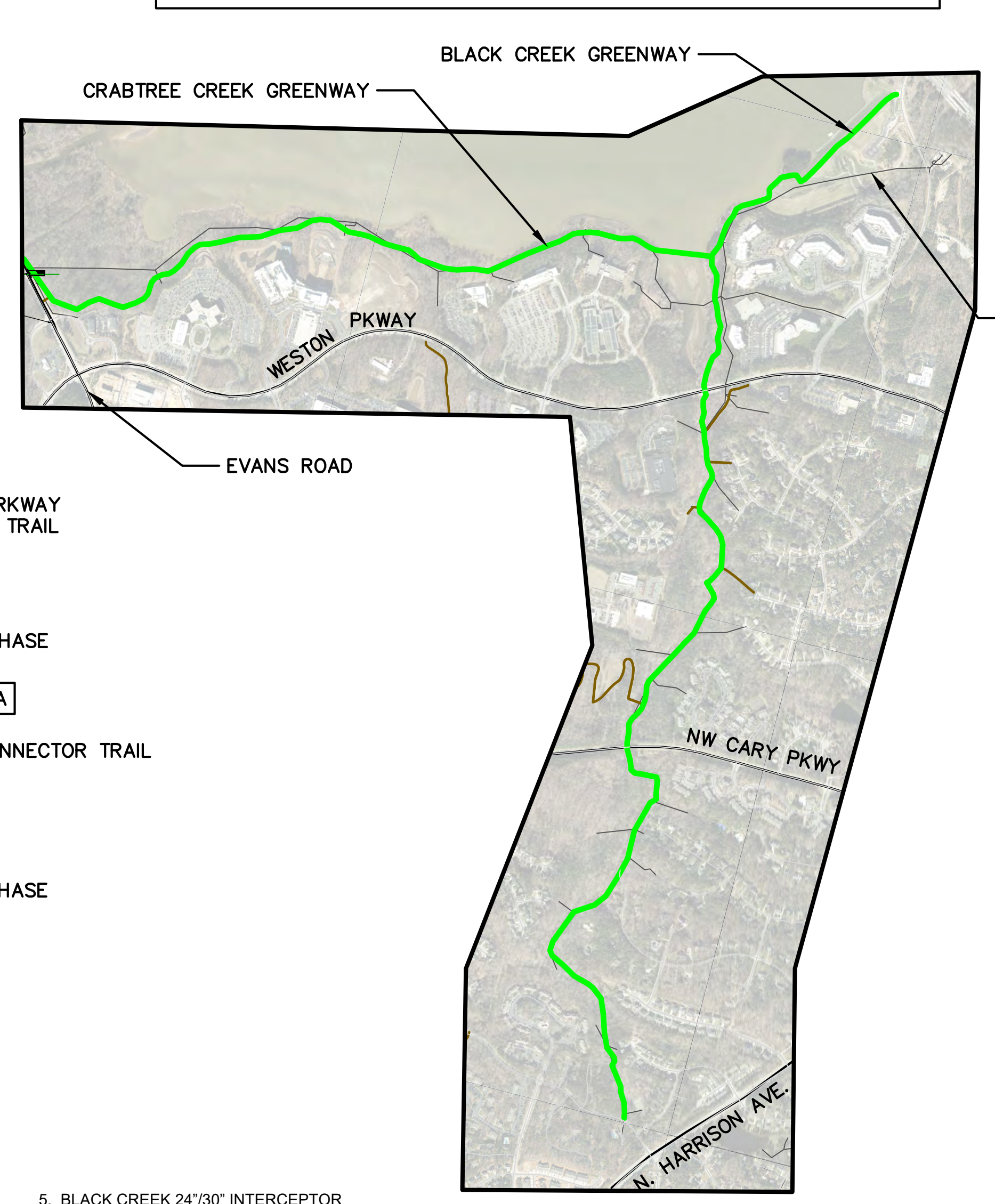
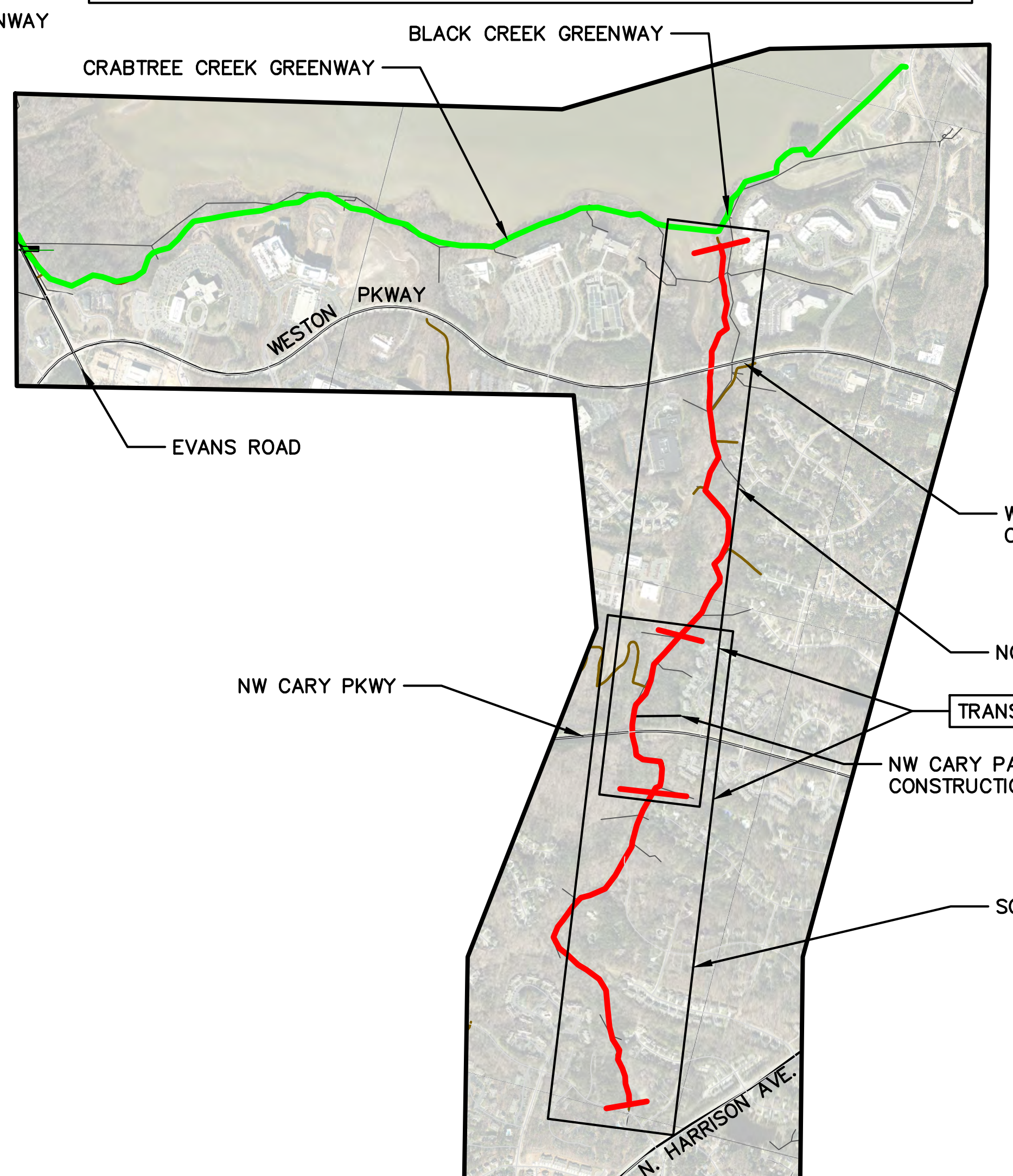
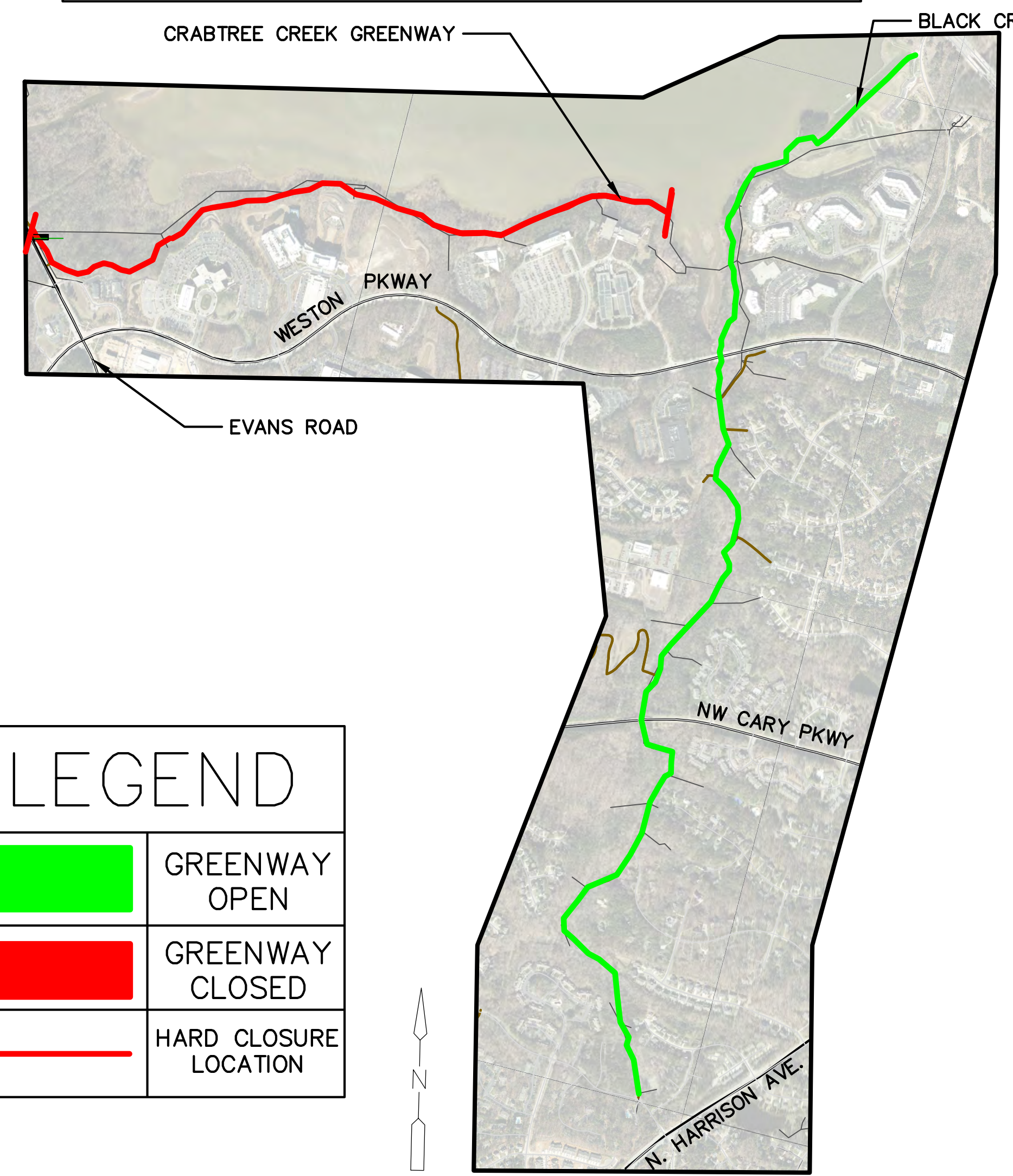

LEGEND	
	GREENWAY OPEN
	GREENWAY CLOSED
	HARD CLOSURE LOCATION

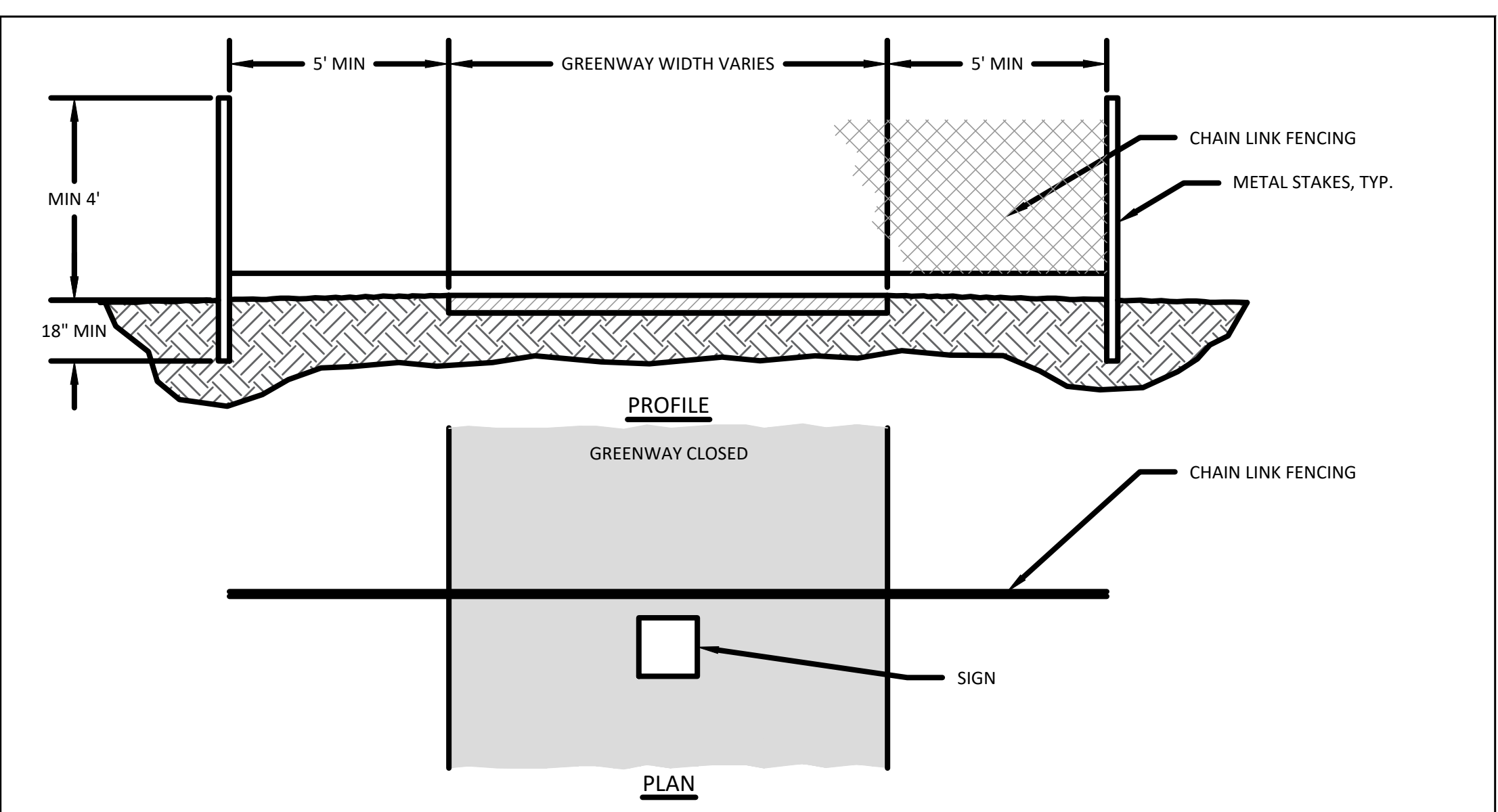

NOTES:

- CONTRACTOR TO CHECK HARD CLOSURES DAILY AND RESECURE/REINSTALL AS NECESSARY.
- SIGN SHALL BE A MINIMUM OF 24" X 36" WITH FONT CLEARLY LEGIBLE FROM 20 FEET. SUBMIT SAMPLE TO ENGINEER FOR APPROVAL. TENTATIVE LANGUAGE FOR THE SIGN IS AS FOLLOWS (FINAL LANGUAGE TO BE PROVIDED AT A LATER DATE):

TOWN OF CARY
FY20-21 SEWER REHABILITATION PROJECT
GREENWAY CLOSED
GREENWAY CLOSURE INFORMATION CAN BE OBTAINED AT _____ WEBSITE

HARD CLOSURE DETAIL

NOTES:

- THIS SHEET SHOWS THE GREENWAY TRAIL SYSTEM IN THE PROJECT AREA. CONSTRUCTION ACCESS POINTS ARE SHOWN UTILIZING EXISTING GREENWAY TRAILS WHERE APPLICABLE. IF THE GREENWAY TRAIL IS NOT SPECIFICALLY SHOWN AS AN ACCESS POINT, IT CANNOT BE USED FOR ACCESS FOR CONSTRUCTION EQUIPMENT. THE CONTRACTOR SHALL EMPLOY SPOTTERS OR FLAGGERS TO ENSURE SAFETY OF THE PUBLIC WHEN UTILIZING THE GREENWAY CONNECTOR TRAILS FOR ACCESS.
SEE NOTE 13 ON SHEET G-1 REGARDING PROTECTING AND/OR REPAIRING THE GREENWAY AS APPROPRIATE.
- ALL GREENWAY CLOSURES SHALL BE SCHEDULED AT LEAST 30 DAYS IN ADVANCE. EACH GREENWAY CLOSURE PLAN SHALL BE SUBMITTED TO THE ENGINEER FOR REVIEW AND COMMENT. THE ENGINEER WILL REVIEW AND COMMENT OR APPROVE. THE CONTRACTOR MUST ADDRESS THE ENGINEER'S COMMENTS AND RESUBMIT UNTIL RESOLVED.
- HARD CLOSURES SHALL BE INSTITUTED WHERE NOTED. HARD CLOSURES SHALL BE PERFORMED BY BLOCKING THE GREENWAY TRAIL AND ANY CONNECTING TRAILS AS SHOWN ON THE DETAIL ON THIS SHEET. ALL WORK WITHIN A HARD CLOSURE SHALL BE PERFORMED BEFORE REOPENING AND MOVING TO ANOTHER AREA. THIS INCLUDES ALL CIPP INSTALLATION, MANHOLE REHABILITATION, OTHER NOTED WORK WITHIN THE AREA, FINAL RESTORATION, AND ALL ELSE RELATED THERETO. AFTER REOPENING, NO ACCESS/WORK SHALL BE PERMITTED IN THE AREA AND NO ADDITIONAL CLOSURES WILL BE PERMITTED.
ONLY ONE SECTION OF THE GREENWAY CAN BE CLOSED AT A TIME SO THAT ACCESS TO ALTERNATE SECTIONS OF THE GREENWAY REMAIN ACCESSIBLE TO THE PUBLIC. SECTIONS OF THE GREENWAY REFER GENERALLY TO THE BLACK CREEK 24"/30" INTERCEPTOR AREA, THE CRABTREE CREEK AREA, AND THE BLACK CREEK 54" INTERCEPTOR AREA.
- CRABTREE CREEK INTERCEPTOR
 - THE ENTIRE CRABTREE GREENWAY IS SHOWN AS CLOSED. HOWEVER, THE WESTERN PORTION OF THE GREENWAY SHALL REMAIN OPEN UNTIL REHABILITATION WORK PROGRESSES DOWNSTREAM TO THE POINT WHERE CLOSURE OF THE GREENWAY IS NECESSARY TO PROVIDE FOR SAFETY OF THE PUBLIC AND CONSTRUCTION PERSONNEL.
 - WHILE THE WESTERN PORTION OF THE GREENWAY IS OPEN, TEMPORARY GREENWAY TRAIL CLOSURES WILL BE PERMITTED IN THE AREA NEAR EVANS ROAD AS REQUIRED FOR BY-PASS PUMP AND PIPING INSTALLATION, MATERIAL DELIVERIES, ETC. FOLLOWING A 7-DAY ADVANCE NOTIFICATION.
 - PEDESTRIAN BRIDGE AT THE EASTERN END OF THE GREENWAY: THE EAST END OF THE PEDESTRIAN BRIDGE SHALL REMAIN OPEN AT ALL TIMES. THE HARD CLOSURE SHALL BE AT THE WEST END OF THE PEDESTRIAN BRIDGE WHEN REQUIRED. WHEN THE HARD CLOSURE IS IN PLACE, THERE SHALL BE A SIGN INSTALLED AT THE EAST END OF THE PEDESTRIAN BRIDGE STATING THAT THE GREENWAY IS CLOSED AHEAD. THE CLOSED AHEAD SIGN SHALL BE A MINIMUM OF 24" X 36" WITH FONT CLEARLY LEGIBLE FROM 20 FEET.
- BLACK CREEK 24"/30" INTERCEPTOR
 - THE SOUTHERN PHASE AND NORTHERN PHASE OF THE GREENWAY CAN BE HARD CLOSED BETWEEN THE LIMITS SHOWN. HOWEVER, DURING SEWER REHABILITATION WORK IN THE SOUTHERN PHASE, GREENWAY TRAILS SHALL REMAIN OPEN IN THE NORTHERN PHASE AND VICE-VERSA.
 - THE TRANSITION AREA WILL REQUIRE TEMPORARY HARD CLOSURES WHILE ALL WORK IS PERFORMED WITHIN THIS LIMITED AREA UNTIL THE ADJACENT PHASE CAN BE ESTABLISHED.
 - PUBLIC ACCESS TO GREENWAY TRAILS FROM CONNECTOR TRAILS AT NW CARY PARKWAY AND WESTON PARKWAY SHALL BE MAINTAINED ALL TIMES DURING CONSTRUCTION, EXCEPT WHEN CONSTRUCTION EQUIPMENT AND VEHICLES ARE ENTERING OR EXITING THE WORK SITE, DURING RELOCATION OF BYPASS PIPING AND PUMPS, TRANSITIONING BETWEEN PHASES, OR OTHER TIMES AS NEEDED AND AGREED UPON.
- BLACK CREEK 54" INTERCEPTOR
 - THE BLACK CREEK GREENWAY BETWEEN THE TRAILHEAD AT OLD REEDY CREEK ROAD AND THE CRABTREE CREEK GREENWAY SHALL REMAIN OPEN TO THE PUBLIC DURING REHABILITATION WORK ON THE BLACK CREEK 54-INCH INTERCEPTOR SEWER LINES AND MANHOLES. IF TEMPORARY CLOSURE OF THE GREENWAY IS NECESSARY TO PROVIDE ADEQUATE SEPARATION BETWEEN THE WORK AREA AND THE PUBLIC, A SHORT-TERM GREENWAY CLOSURE MAY BE ALLOWED. THE CONTRACTOR SHALL IDENTIFY ANY SUCH LOCATIONS AT THE ONSET OF THE PROJECT AND NOTIFY THE OWNER AND ENGINEER IN WRITING A MINIMUM OF THIRTY DAYS IN ADVANCE OF THE CLOSURE.
WHILE THE GREENWAY IS OPEN TO THE PUBLIC, THE CONTRACTOR SHALL EXERCISE EXTREME CAUTION AT ALL TIMES. WHEN UTILIZING THE GREENWAY FOR CONSTRUCTION ACCESS, THE CONTRACTOR SHALL EMPLOY THE USE OF SPOTTERS TO ENSURE THAT PEDESTRIANS AND/OR BICYCLISTS ARE KEPT AT A SAFE DISTANCE.
 - NO BY-PASS DISCHARGE PIPING SHALL CROSS ANY GREENWAY TRAIL ABOVE GROUND. ALL BY-PASS PUMPING DISCHARGE PIPING SHALL BE BURIED UNDER THE GREENWAY TRAIL. CUT AND REPLACE ASPHALT TO MATCH EXISTING BOTH AFTER INSTALLATION AND AT REMOVAL. THIS COST SHALL BE INCLUDED WITH THE BY-PASS PUMPING COST AND NO ADDITIONAL PAYMENT WILL BE MADE.
 - ALL COSTS TO ACCOMPLISH THE TASKS ON THIS SHEET AND ALL COORDINATION OF THE GREENWAY CLOSURES, REOPENINGS, AND ALL RELATED THERETO ARE MANDATORY SUBSIDIARY OBLIGATIONS UNDER THE CONTRACT, AND NO SEPARATE PAYMENT WILL BE MADE.

REVISIONS	CARY PROJECT No.: SW3501
	PROJECT No.: TOC-010
	DESIGNED BY:
	DRAWN BY: A. SPIROU
	CHECKED BY: M. COLANGELO
	APPROVED BY: M. LAMBERT
	DATE: MARCH 2021

Frazier Engineering, P.A.
6592 Bob White Trail
Stanley, NC 28164
Office 704.822.8444
Fax 704.822.8666

TOWN OF CARY
CARY, NORTH CAROLINA

**FY 20-21 SEWER INTERCEPTOR
REHABILITATION PROJECT**

GREENWAY COORDINATION REQUIREMENTS

SHEET No.
C-7

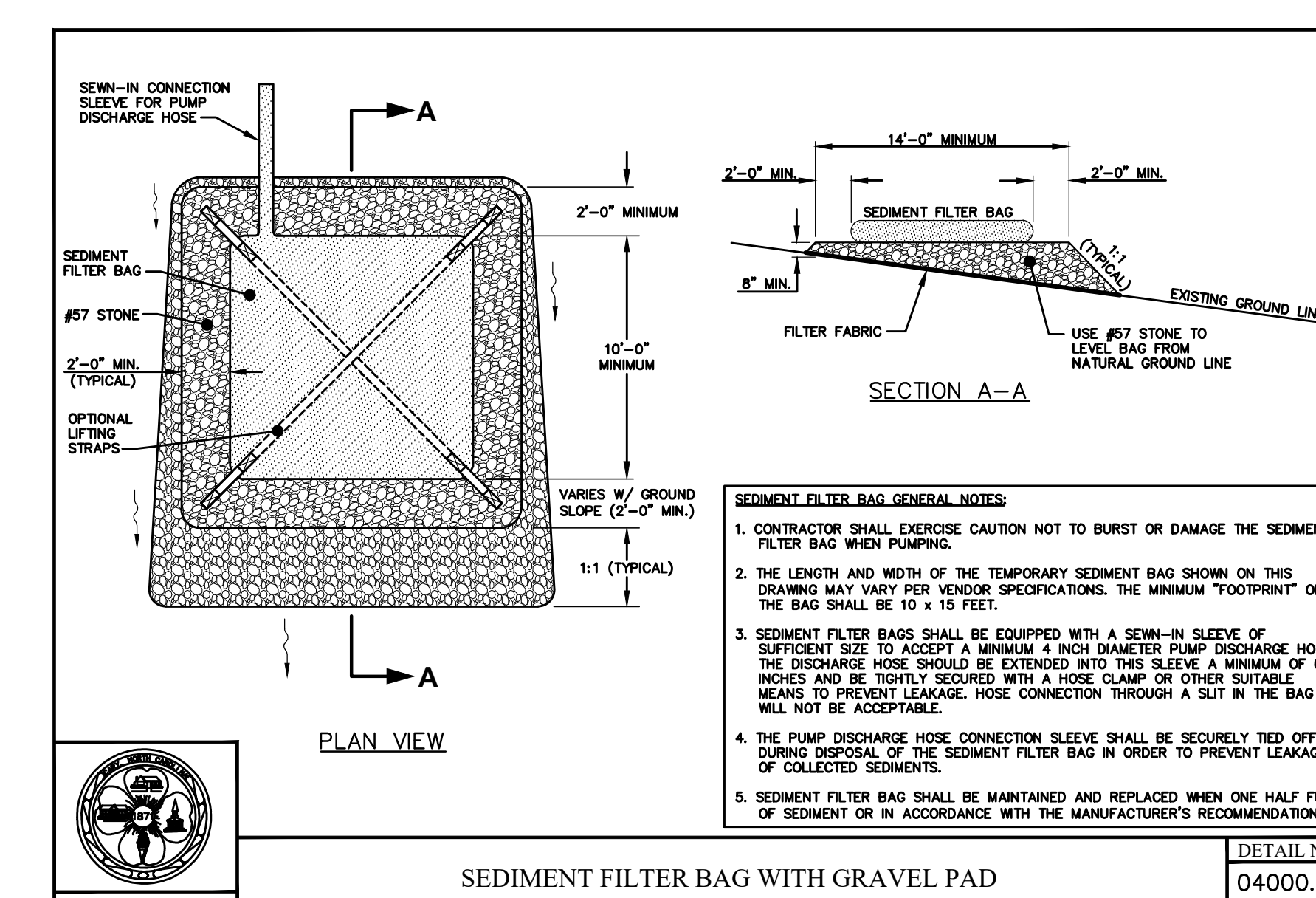
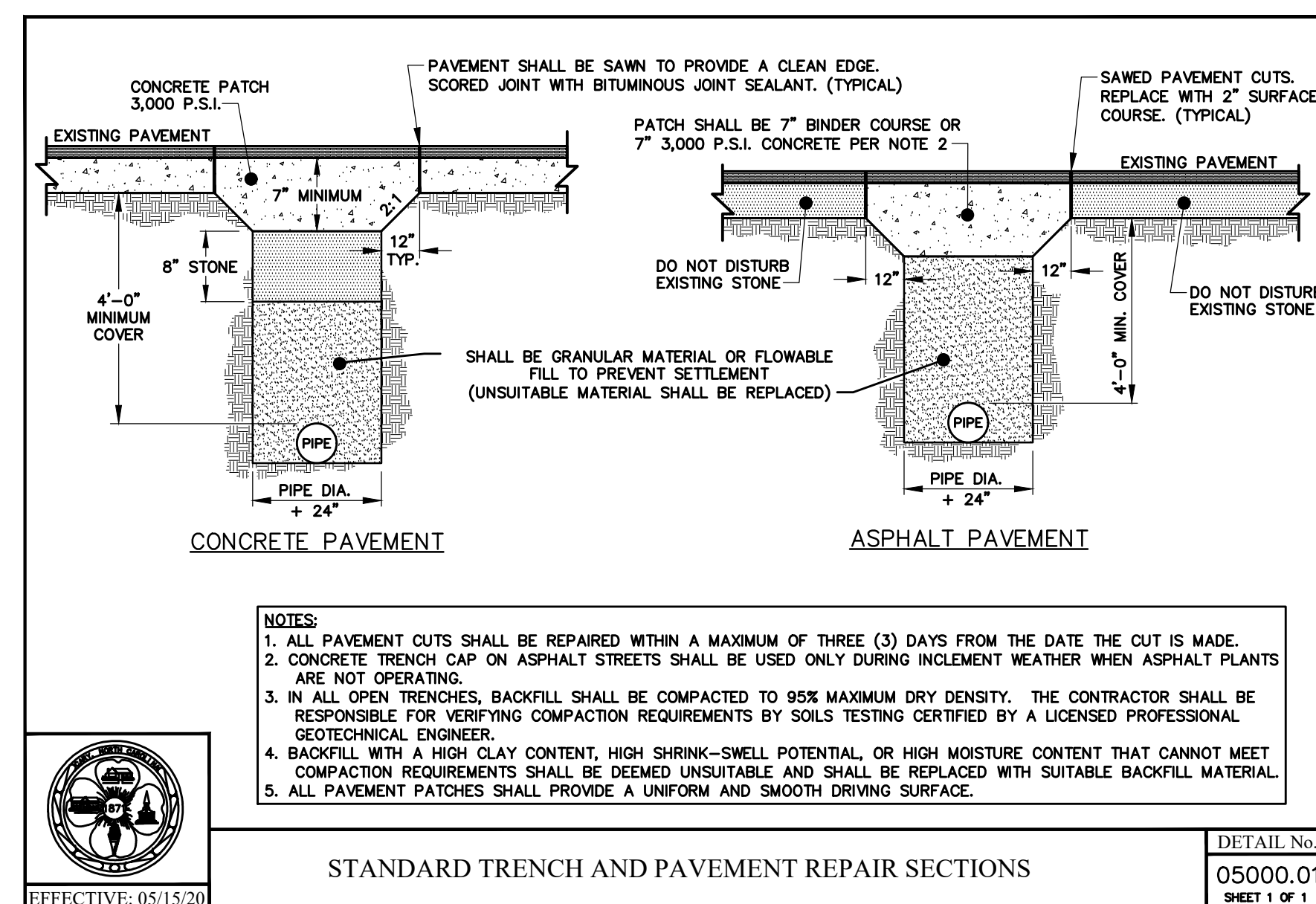
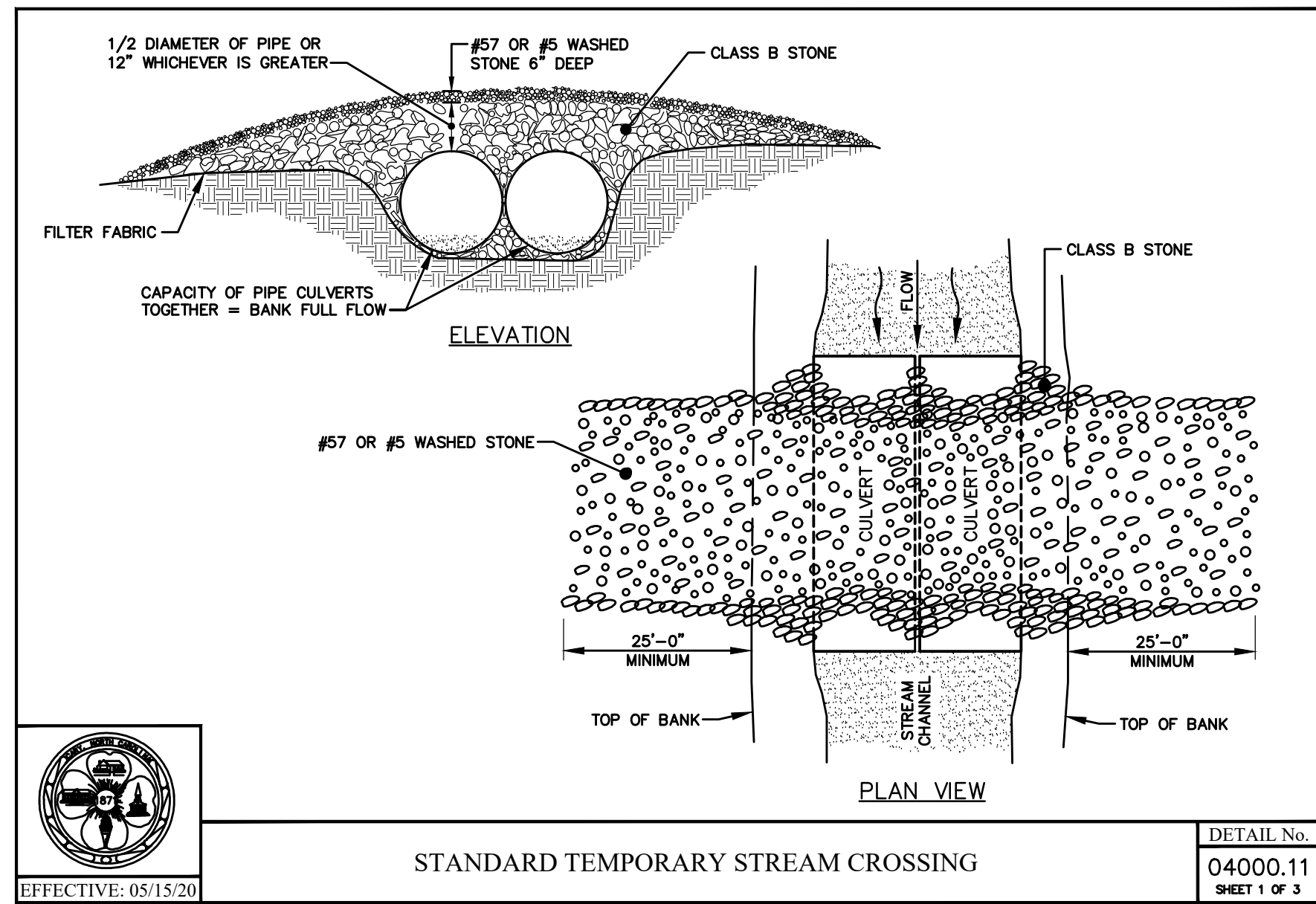
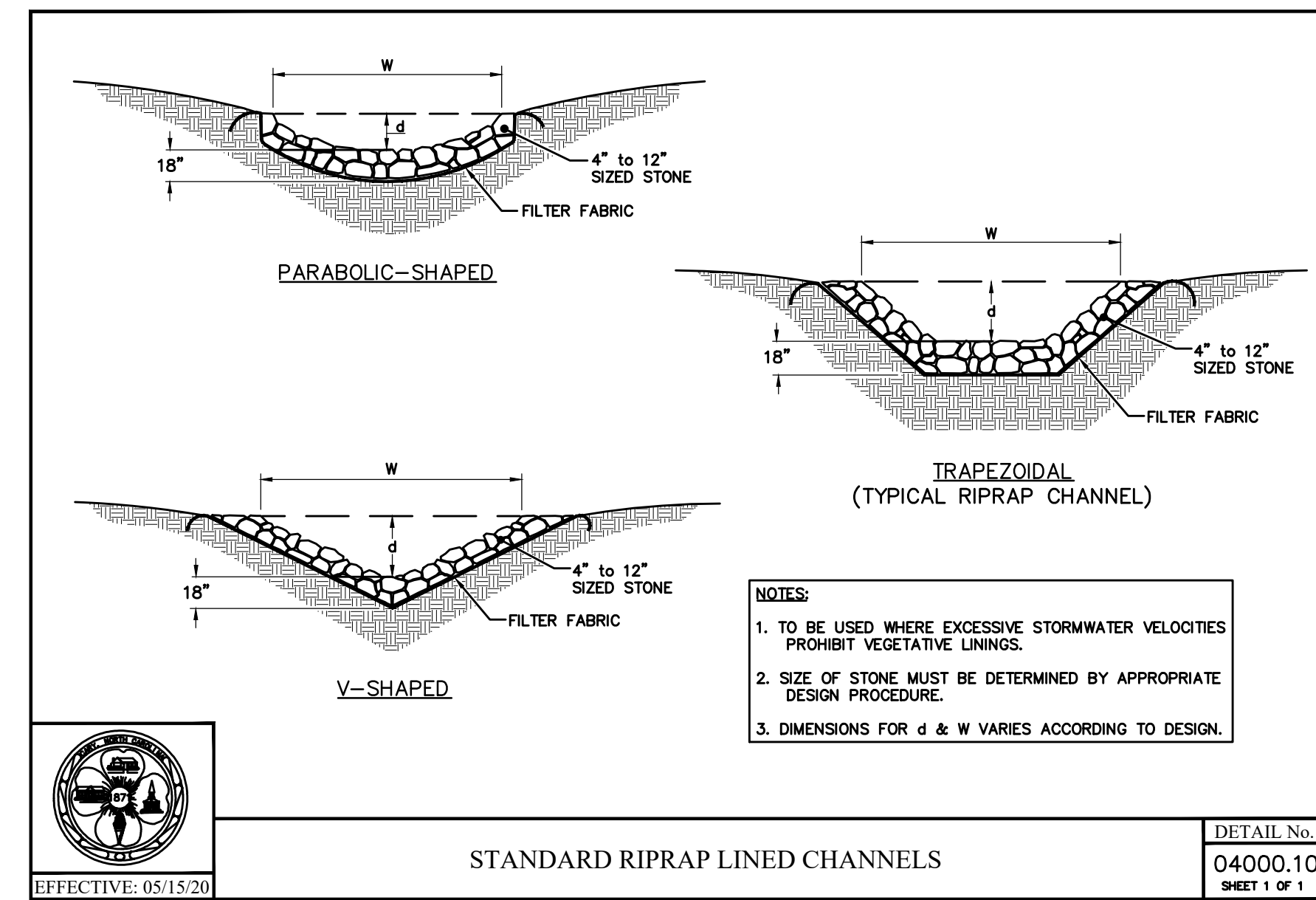
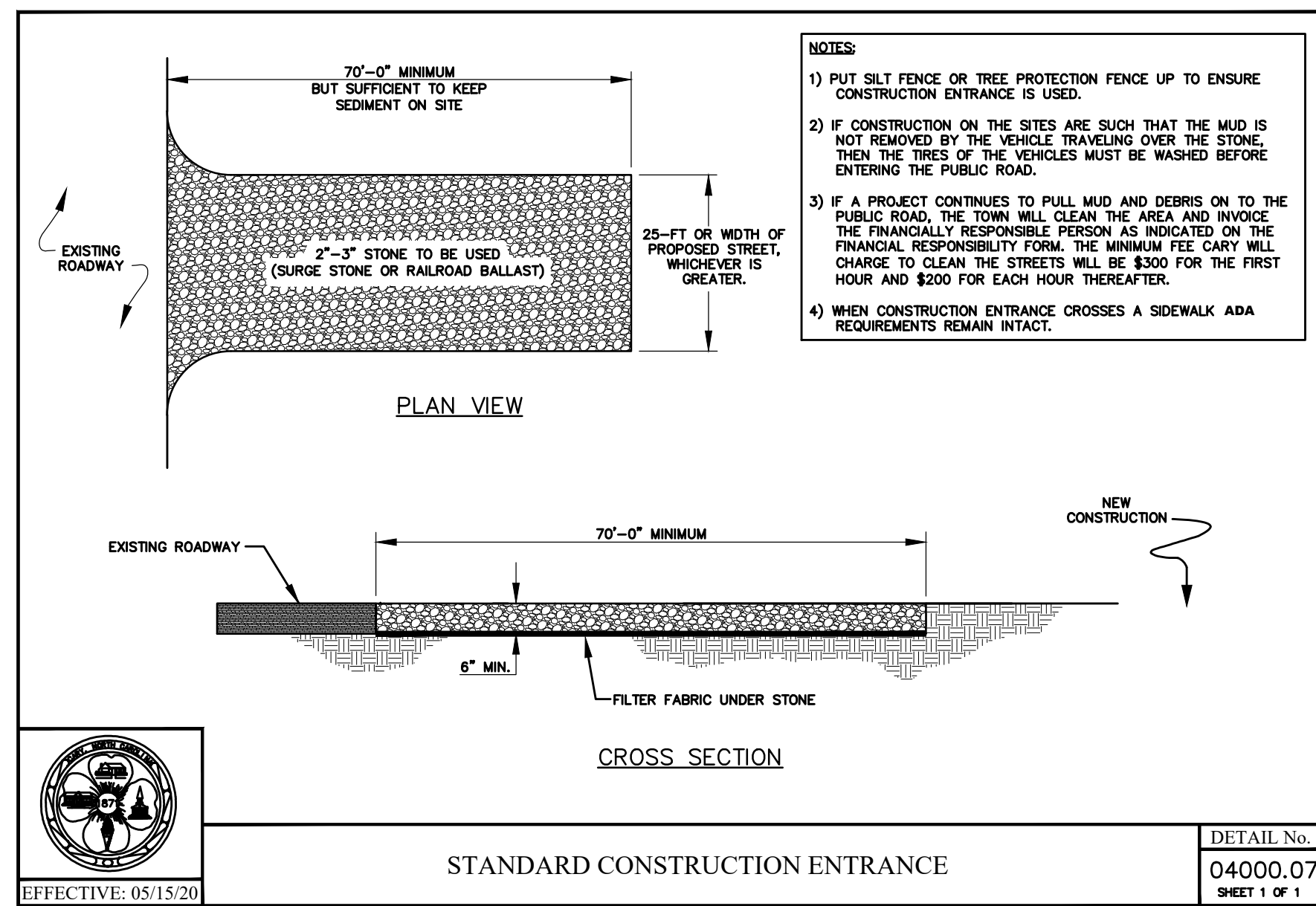
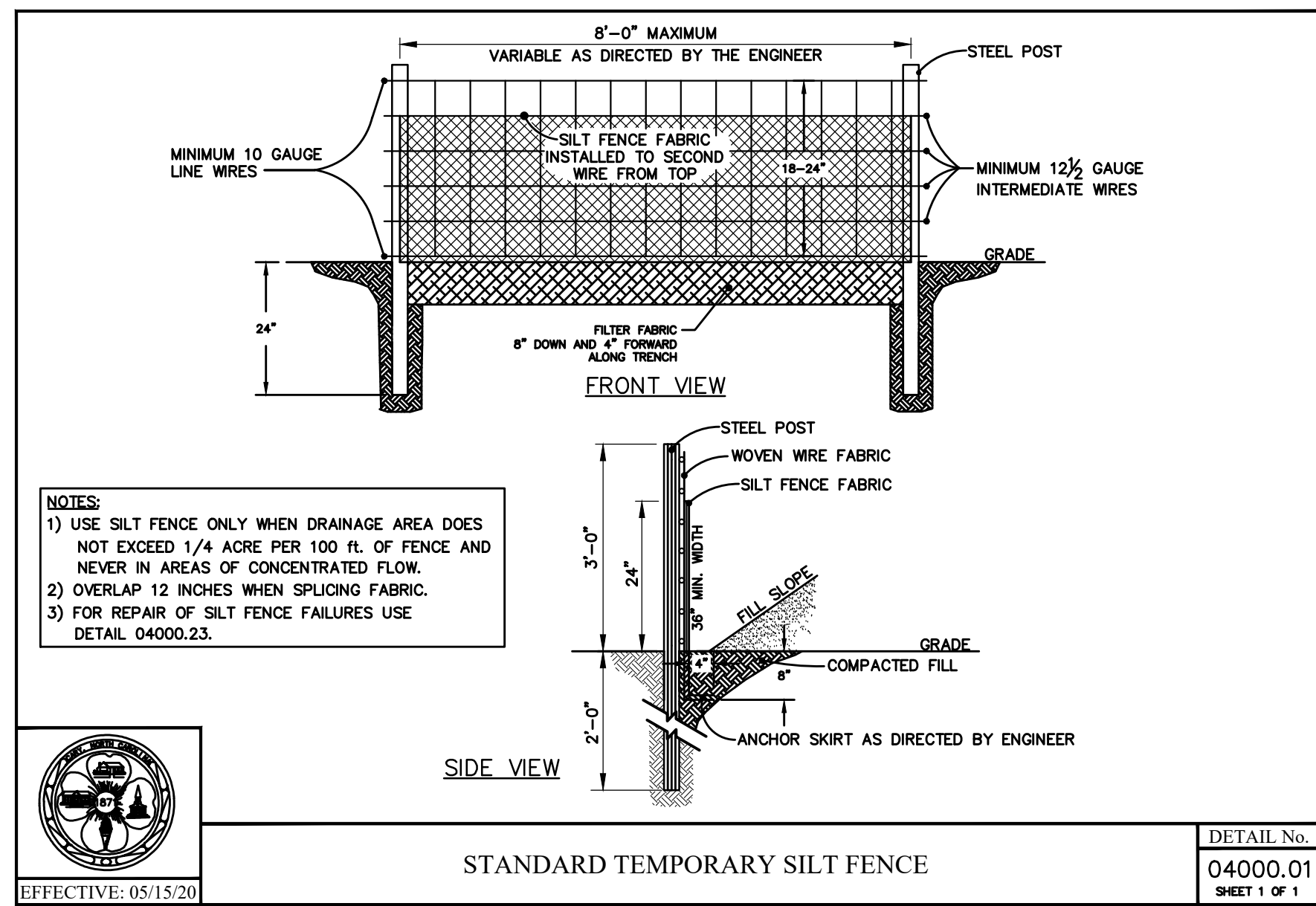

REVISIONS	CARY PROJECT No.: SW3501			TOWN OF CARY CARY, NORTH CAROLINA	SHEET No. D-1	
	PROJECT No.: TOC-010			FY 20-21 SEWER REHABILITATION PROJECT		
	DESIGNED BY:					DETAILS
	DRAWN BY: A. SPIROU					
	CHECKED BY: M. COLANGELO					
	APPROVED BY: M. LAMBERT					
DATE: MARCH 2021	Frazier Engineering, P.A. 6592 Bob White Trail Stanley, NC 28164 Office 704.822.8444 Fax 704.822.8666					

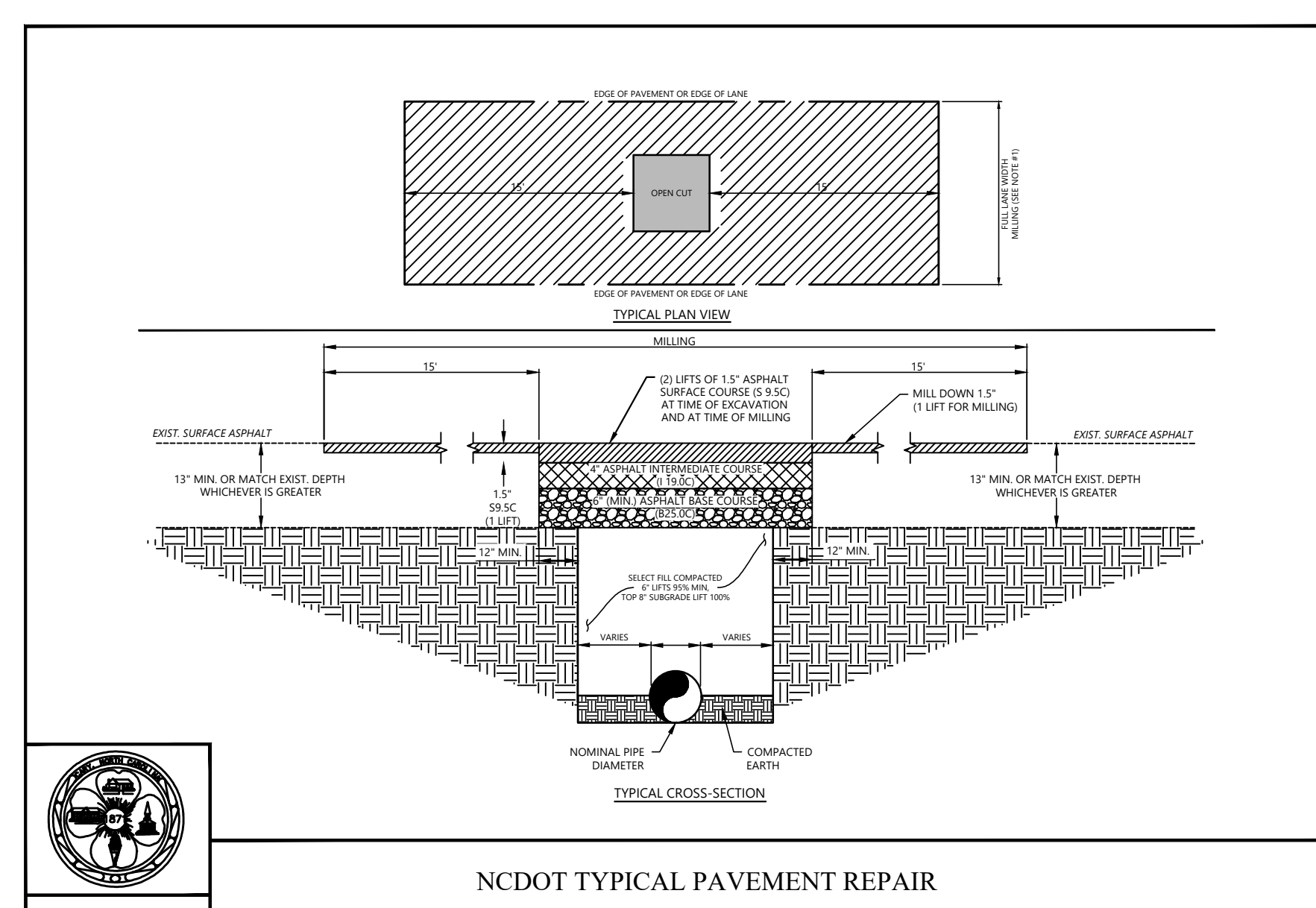
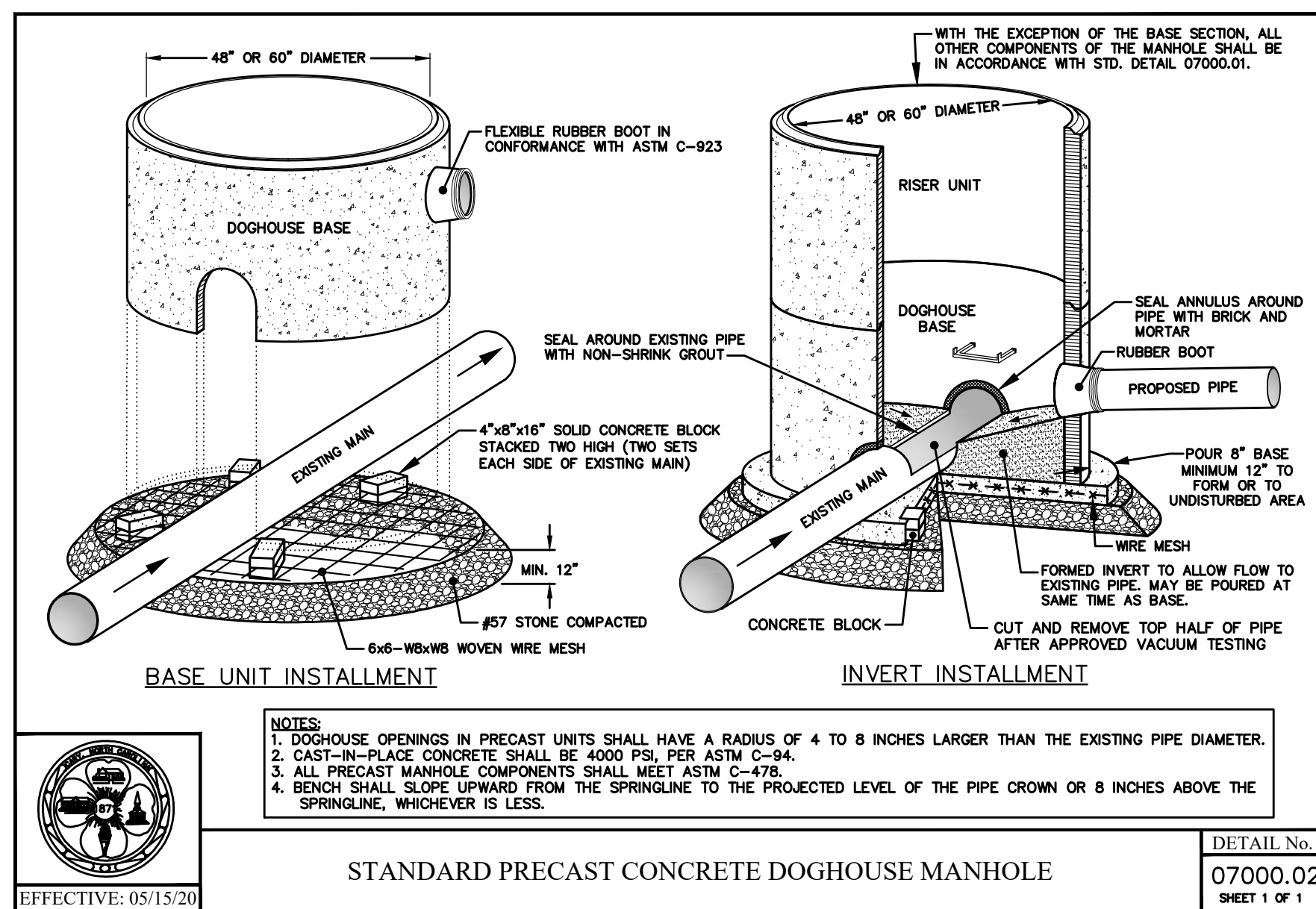
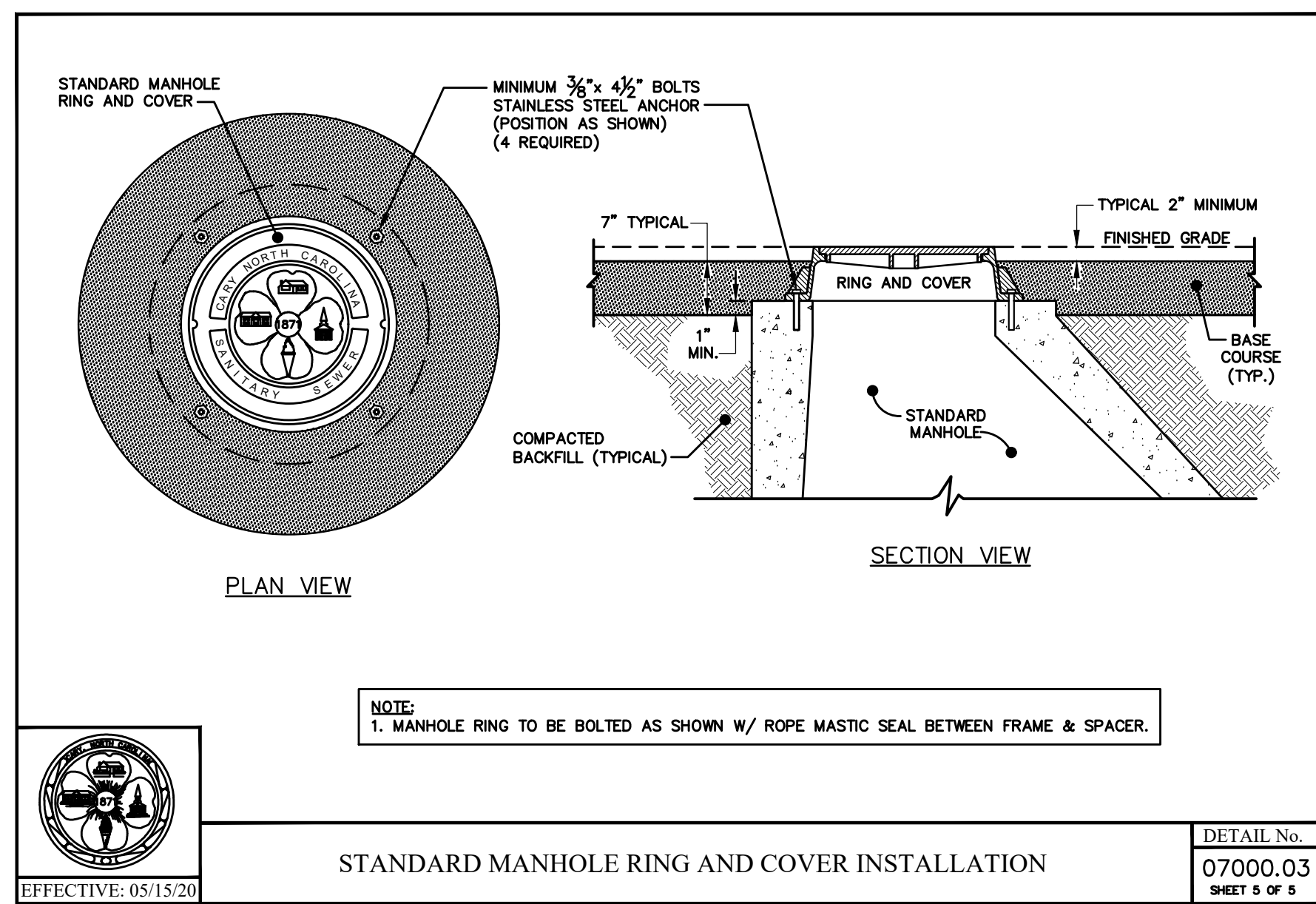
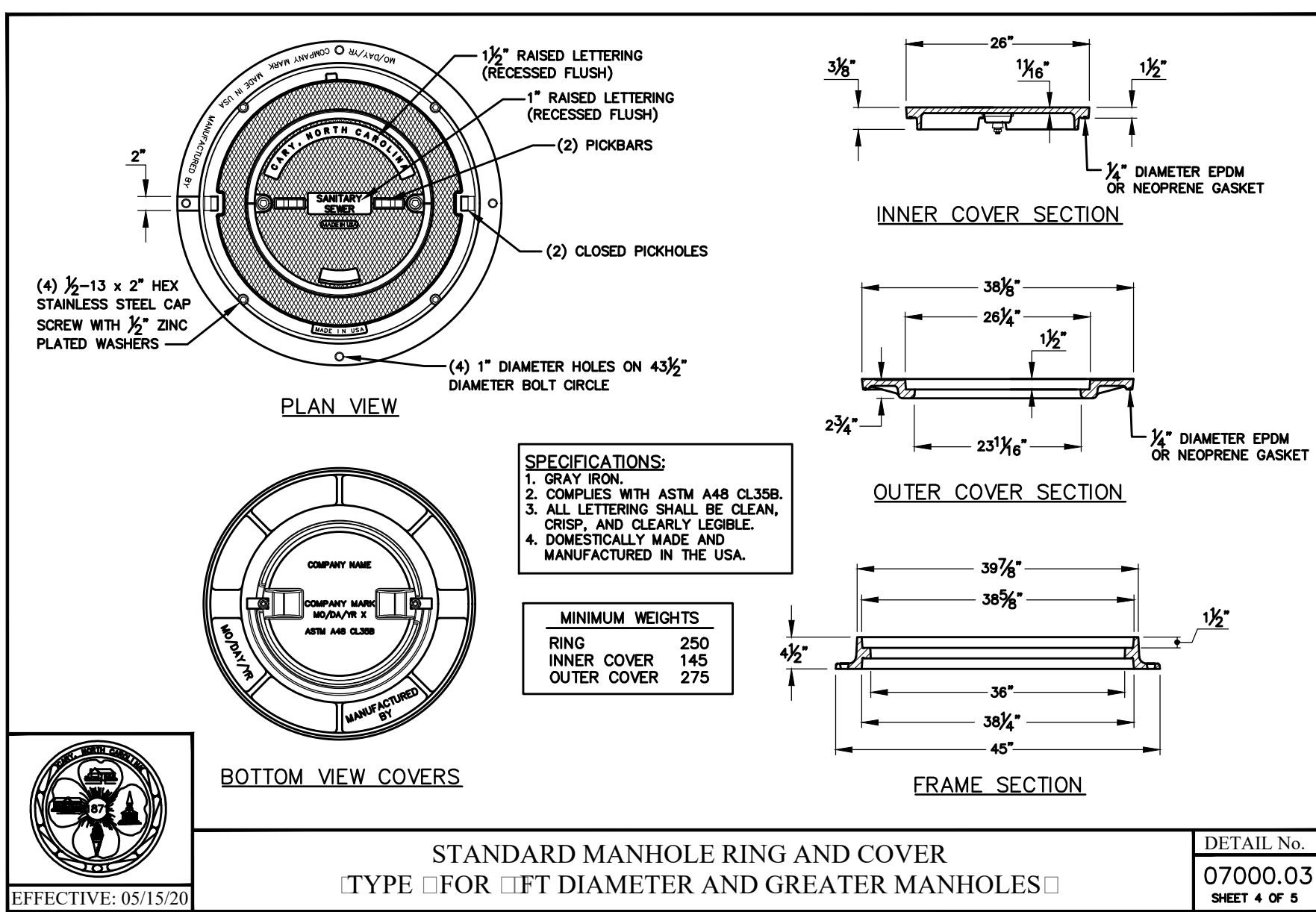
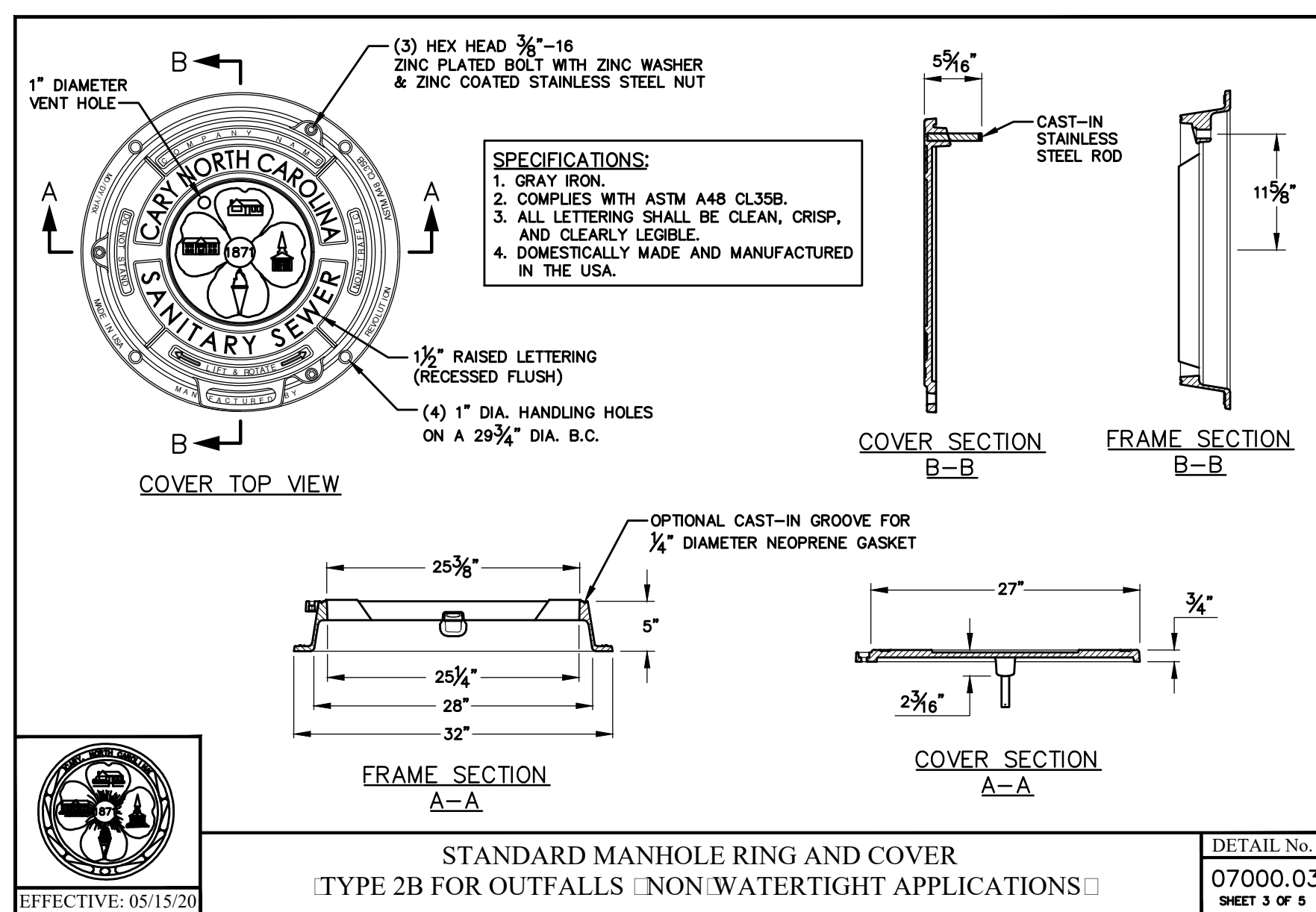
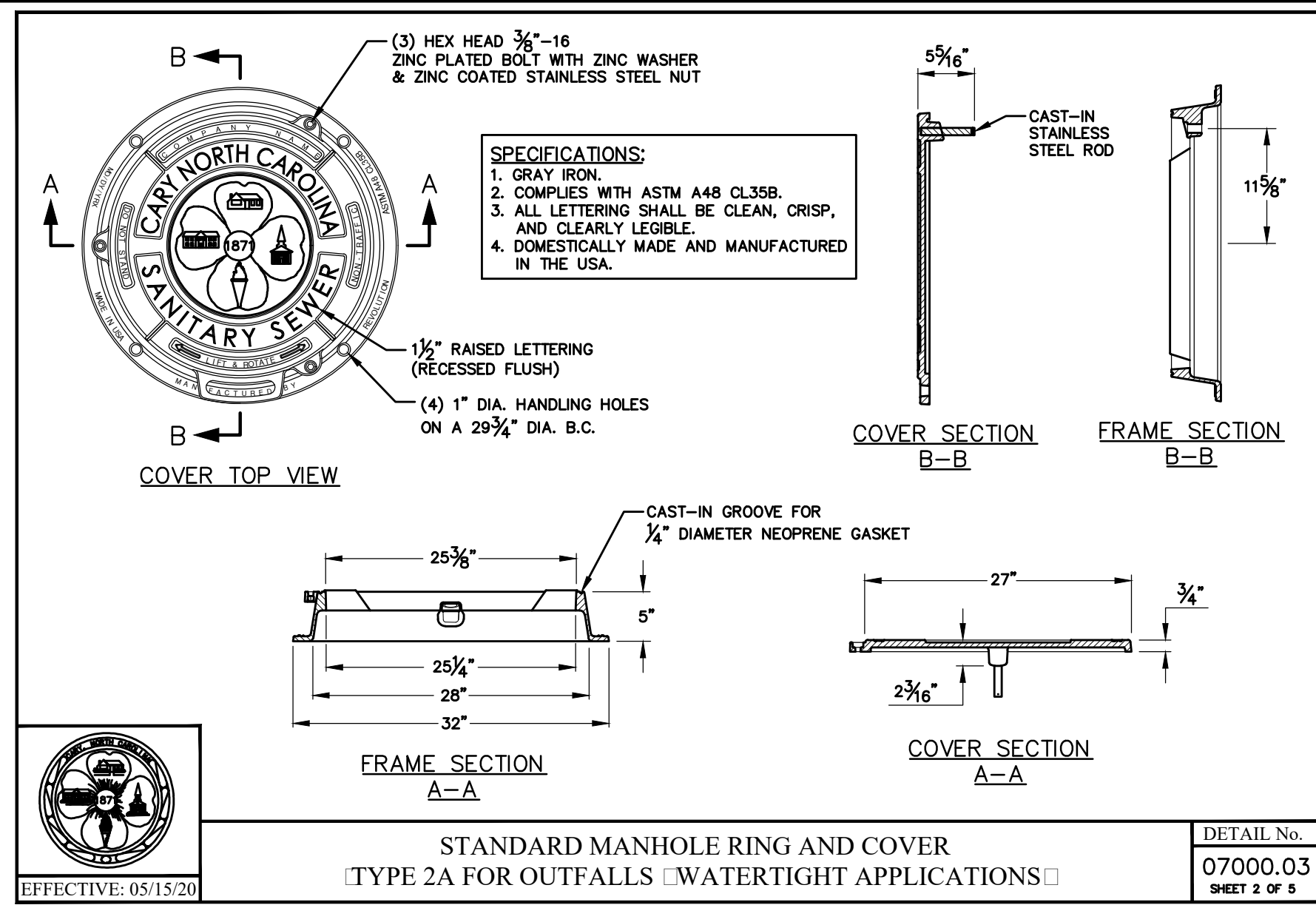
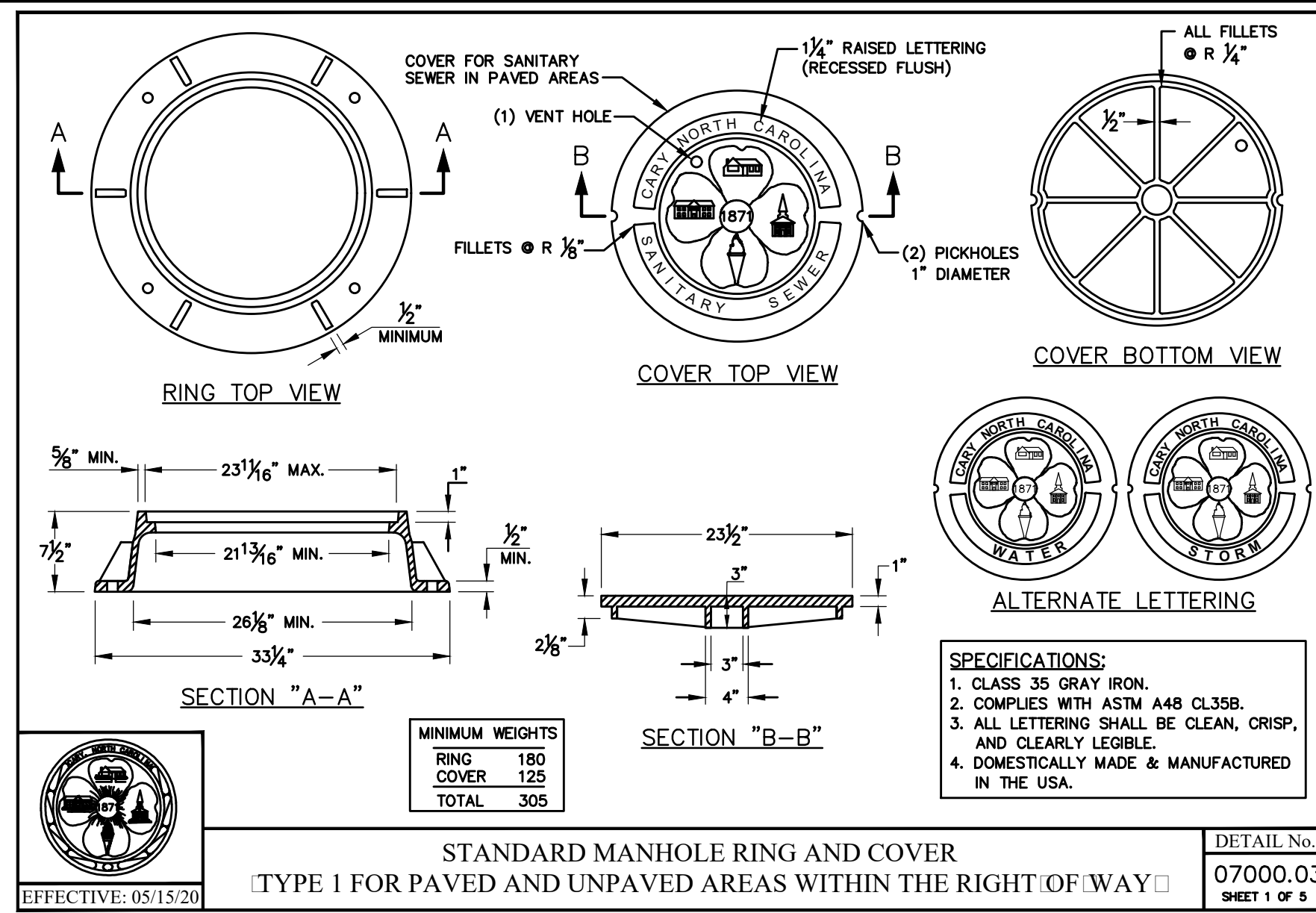
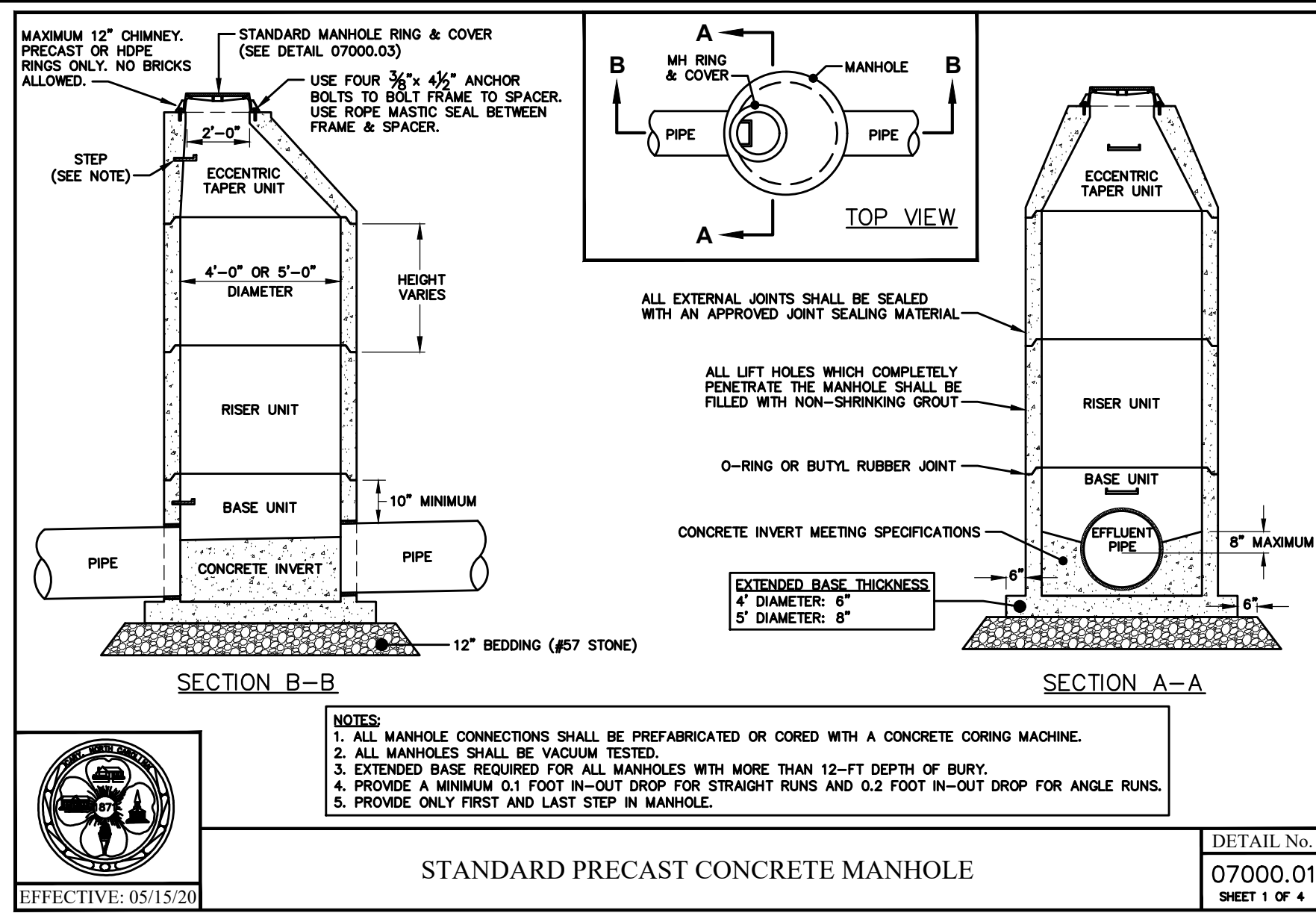

REVISIONS 	CARY PROJECT No.: SW3501		Frazier Engineering, P.A. 6592 Bob White Trail Stanley, NC 28164 Office 704.822.8444 Fax 704.822.8666	TOWN OF CARY CARY, NORTH CAROLINA FY 20-21 SEWER REHABILITATION PROJECT DETAILS	SHEET No. D-2
	PROJECT No.: TOC-010				
	DESIGNED BY:				
	DRAWN BY: A. SPIROU				
	CHECKED BY: M. COLANGELO				
	APPROVED BY: M. LAMBERT				
DATE: MARCH 2021					

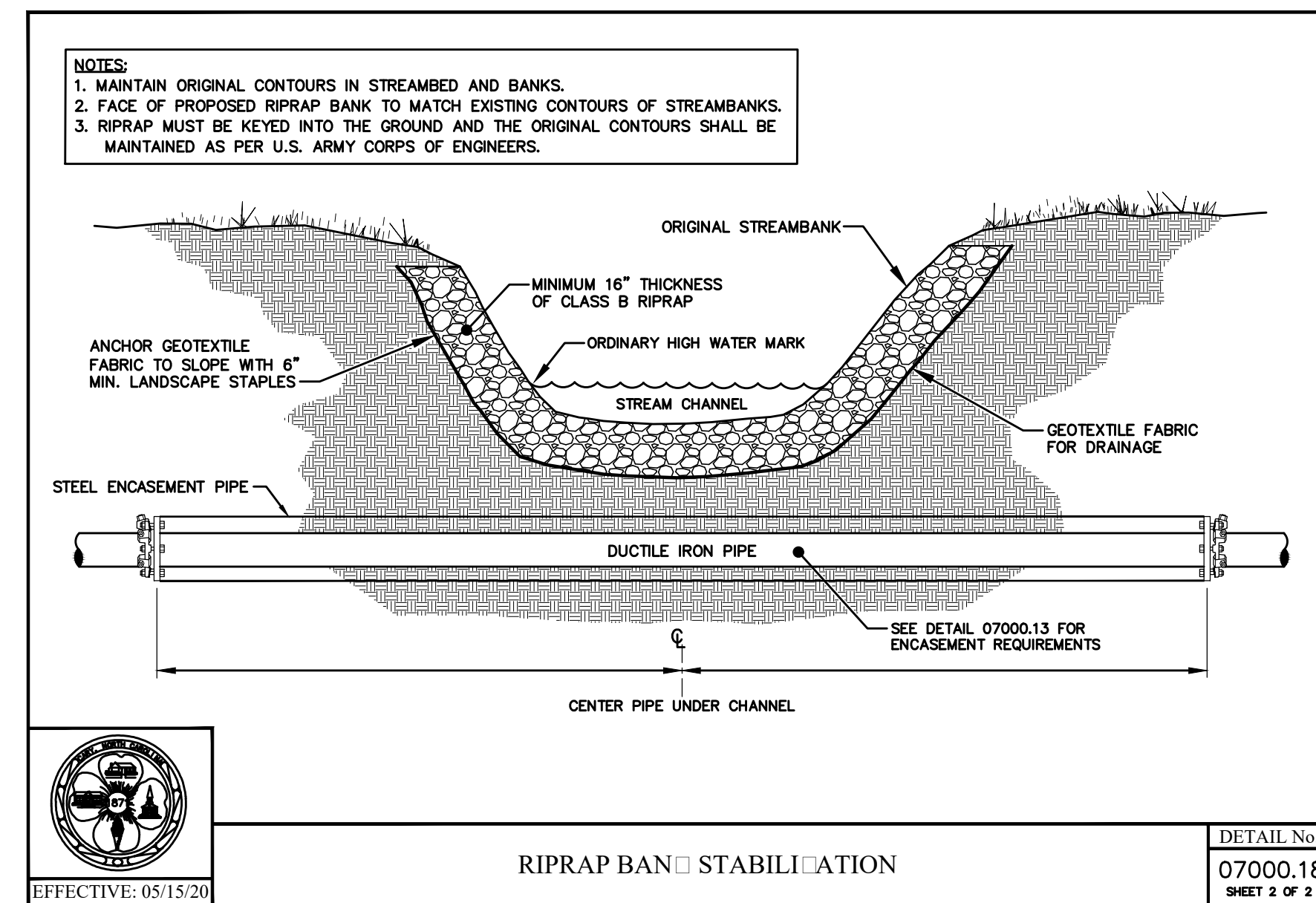
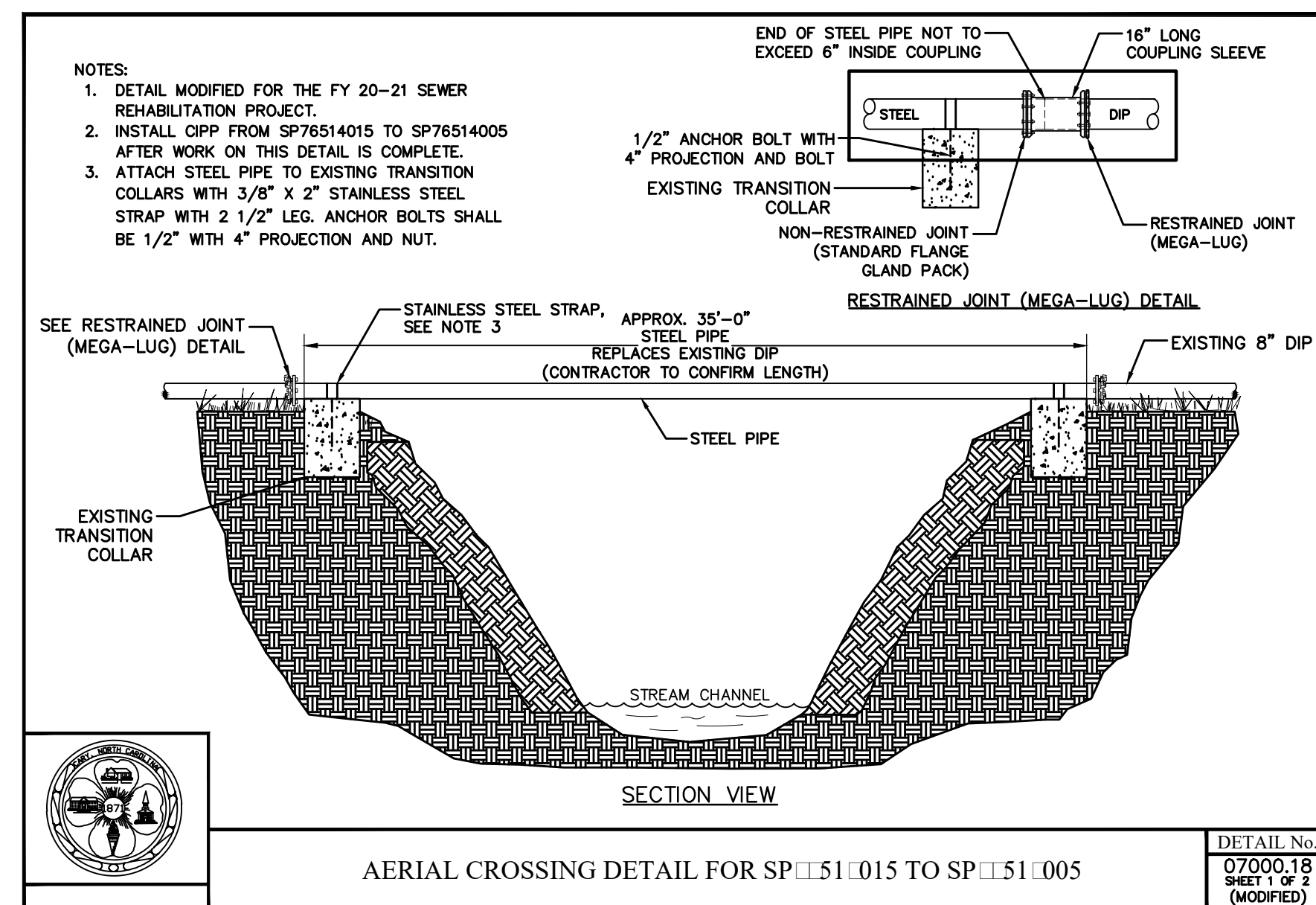
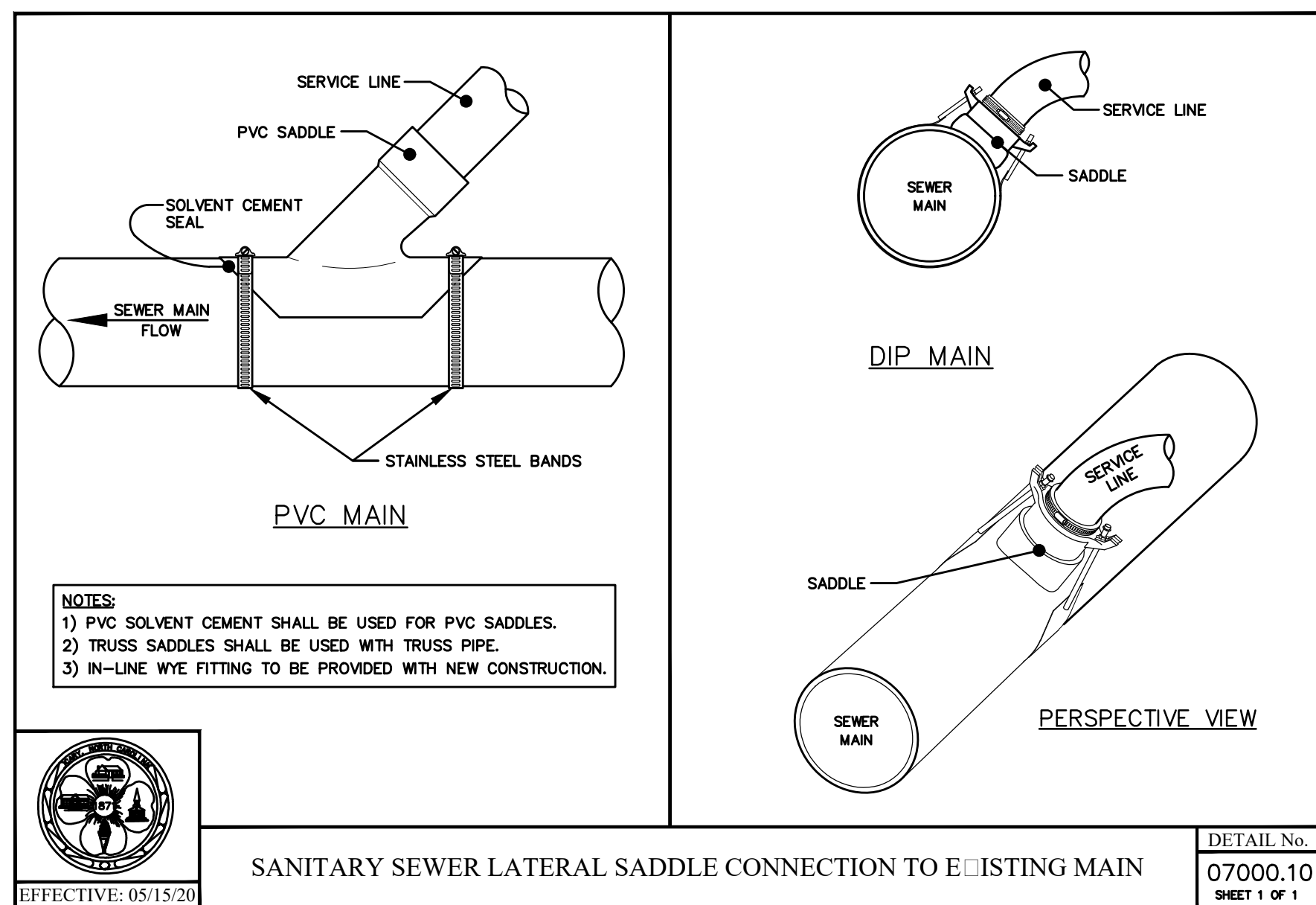
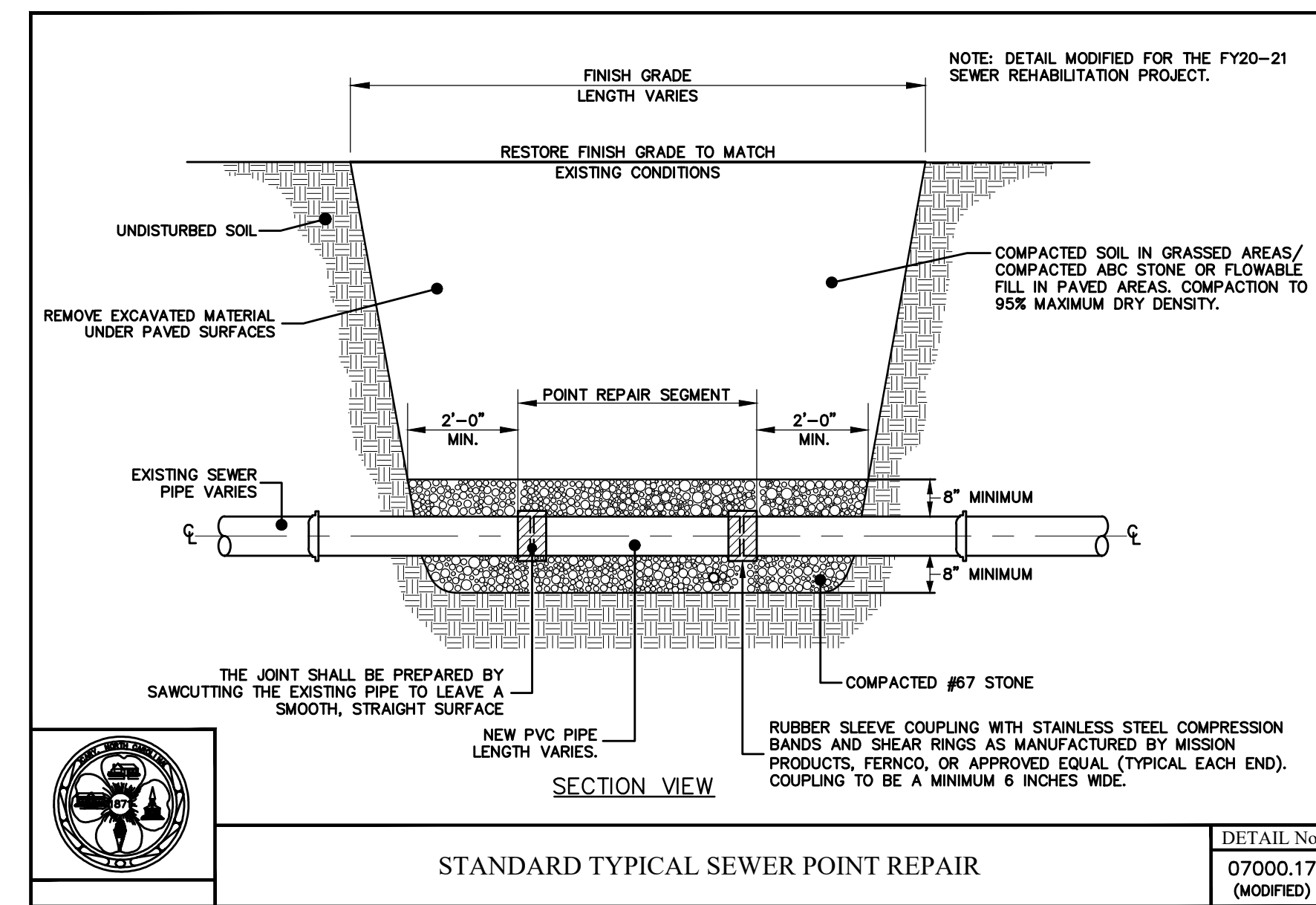
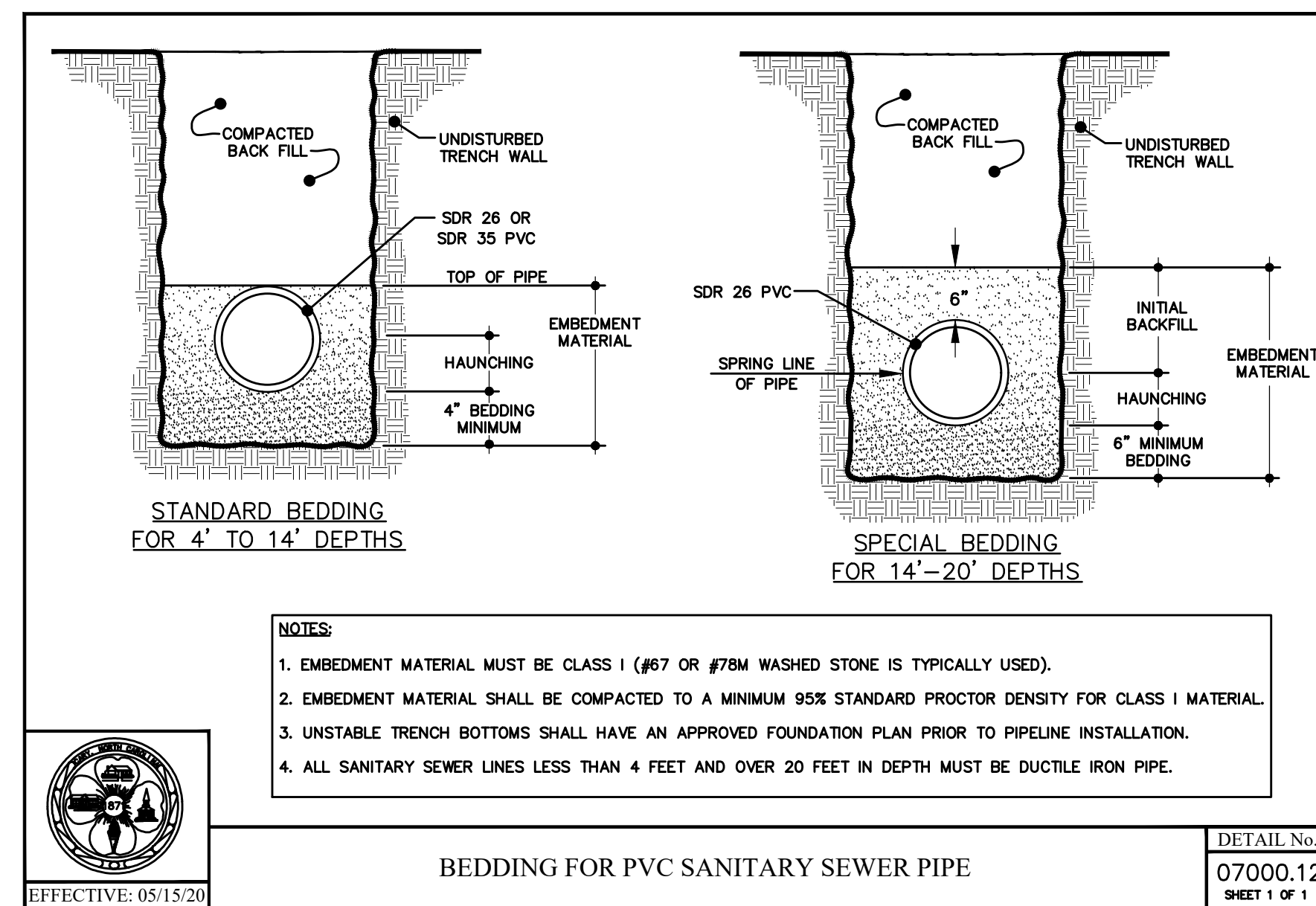
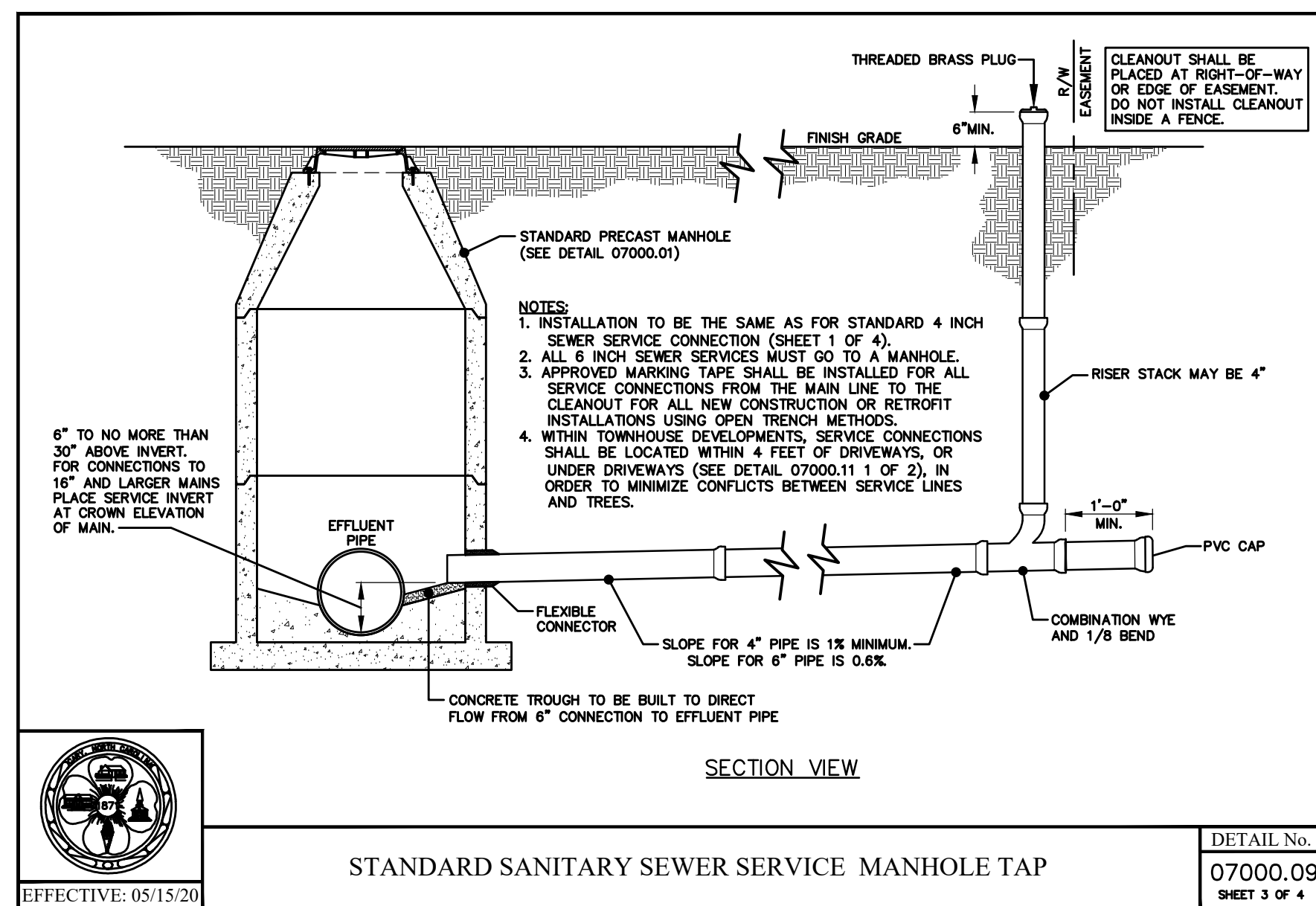
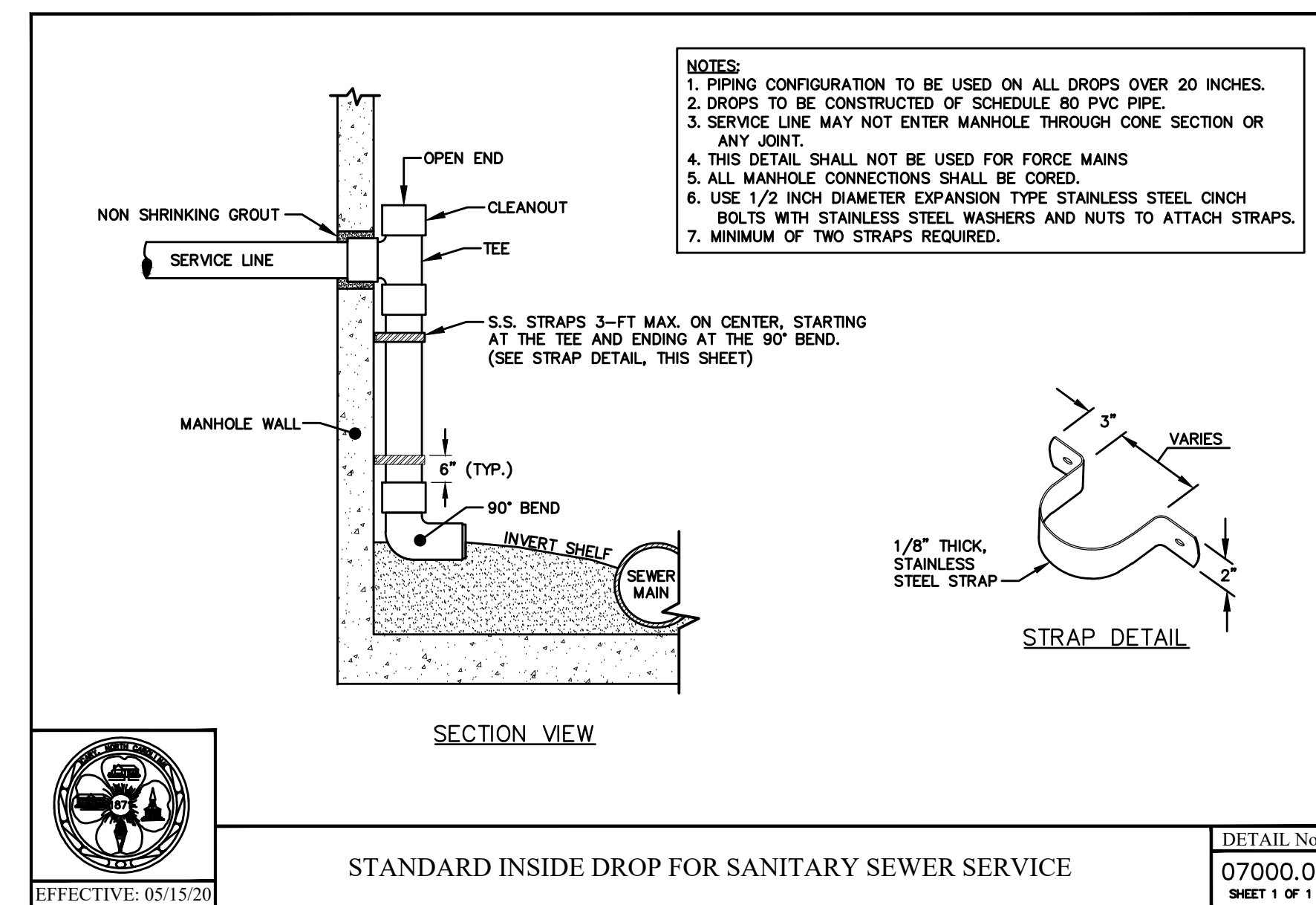
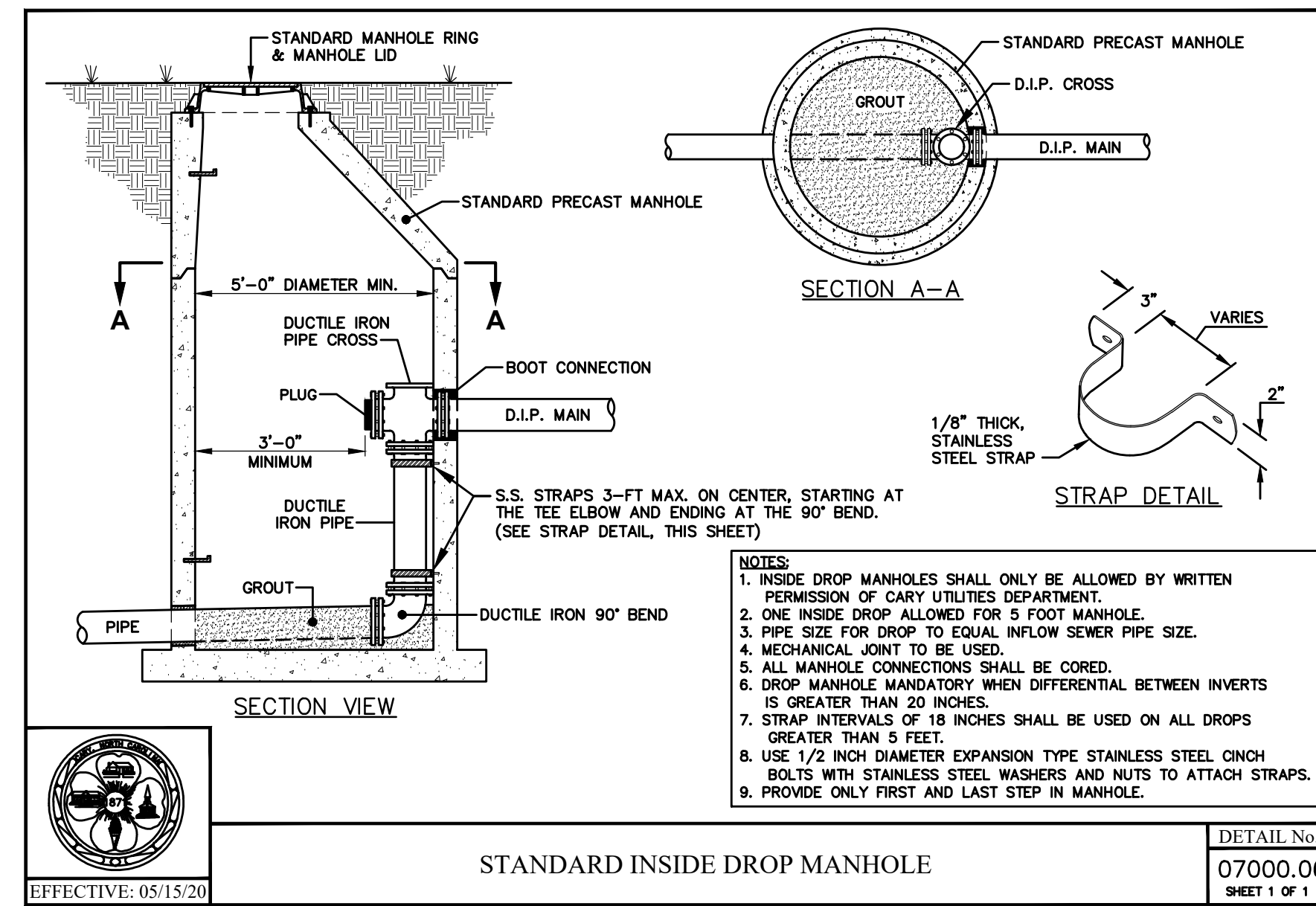
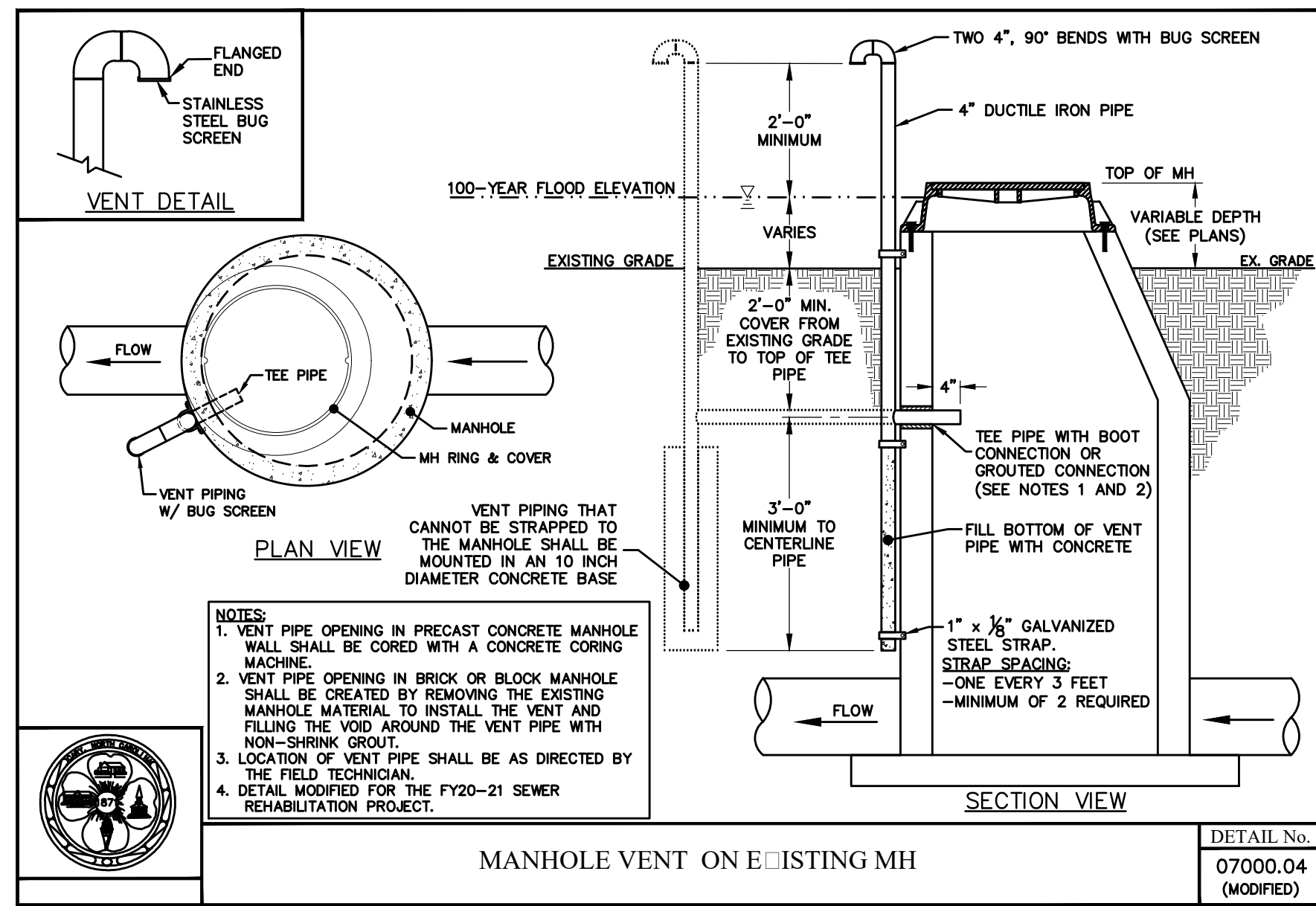

REVISIONS	CARY PROJECT No.: SW3501	PROJECT No.: TOC-010	DESIGNED BY:	DRAWN BY: A. SPIROU	CHECKED BY: M. COLANGELO	APPROVED BY: M. LAMBERT	DATE: MARCH 2021

MARK E. LAMBERT
ENGINEER
22098

Frazier Engineering, P.A.
6592 Bob White Trail
Stanley, NC 28164
Office 704.822.8444
Fax 704.822.8666

TOWN OF CARY
CARY, NORTH CAROLINA

**FY 20-21 SEWER
REHABILITATION PROJECT**

DETAILS

SHEET No. D-3

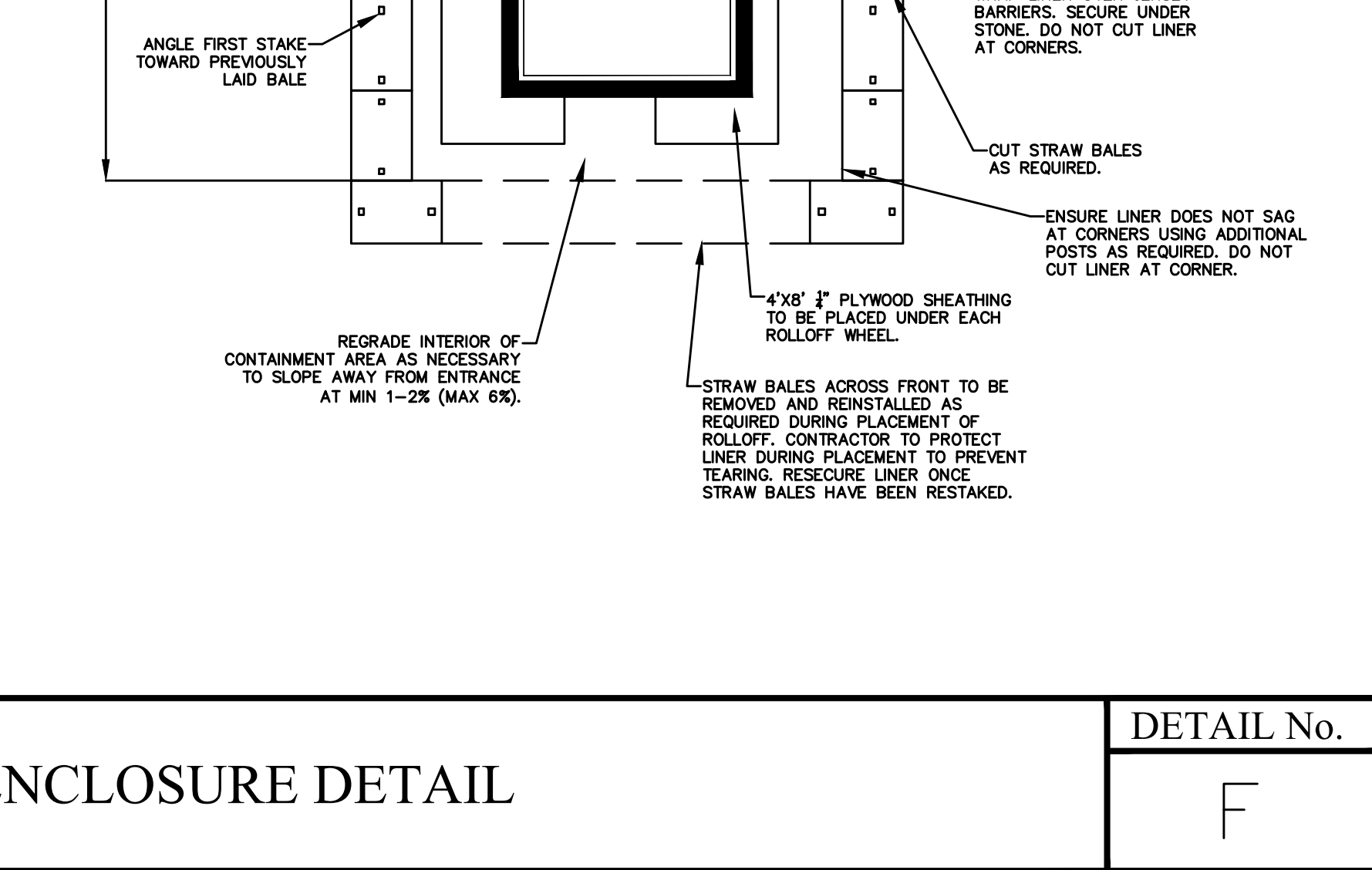
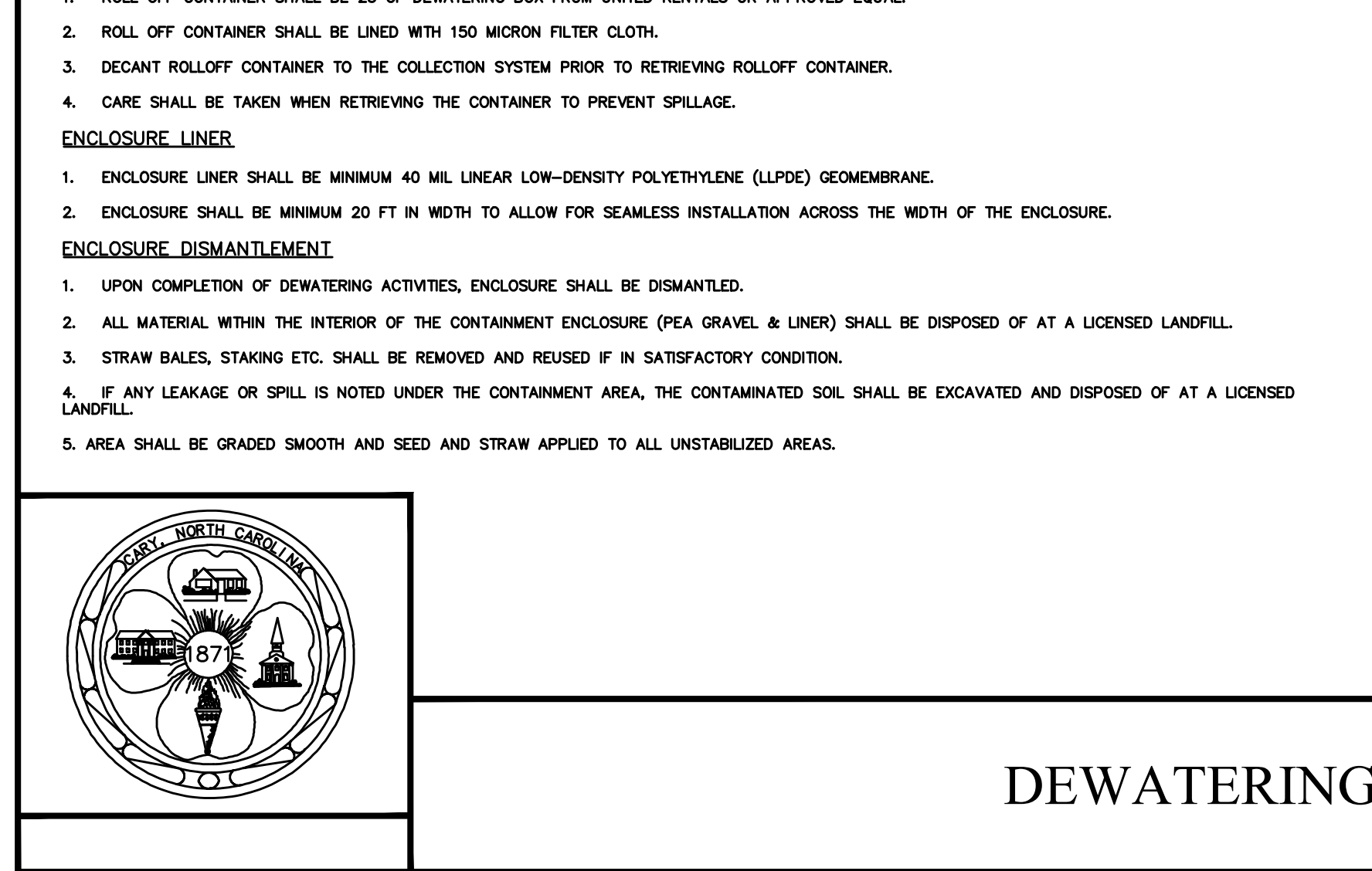
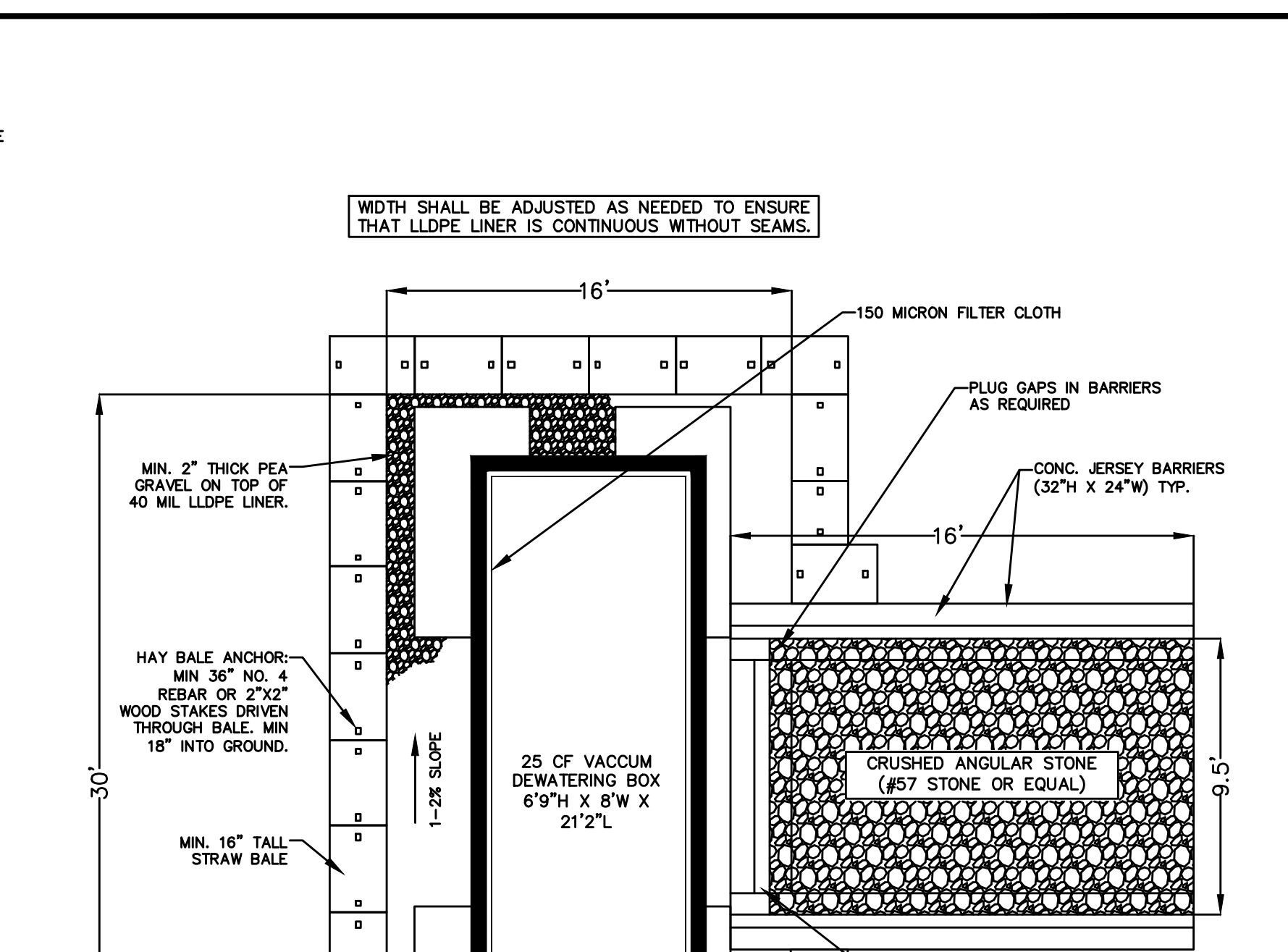
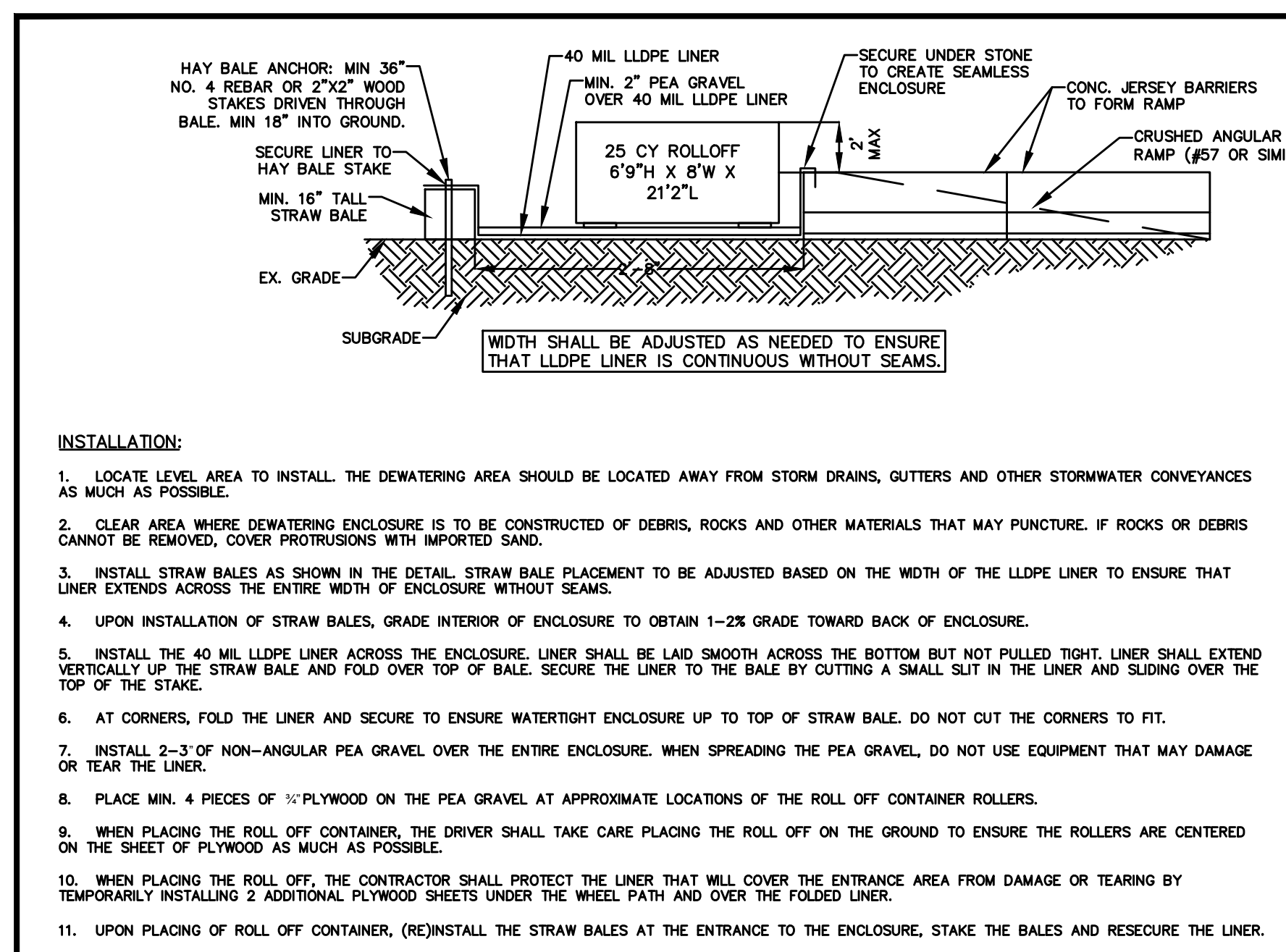
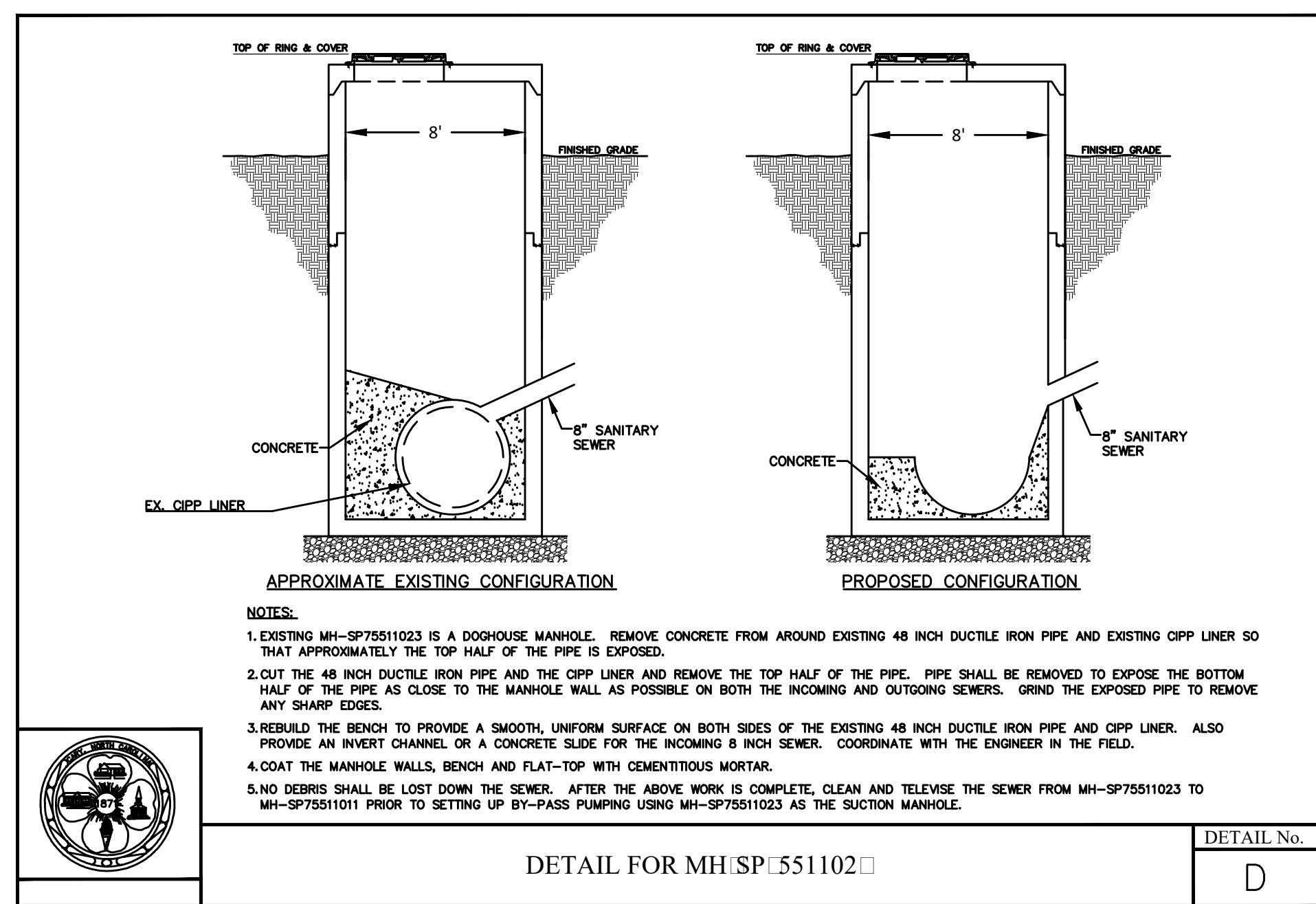
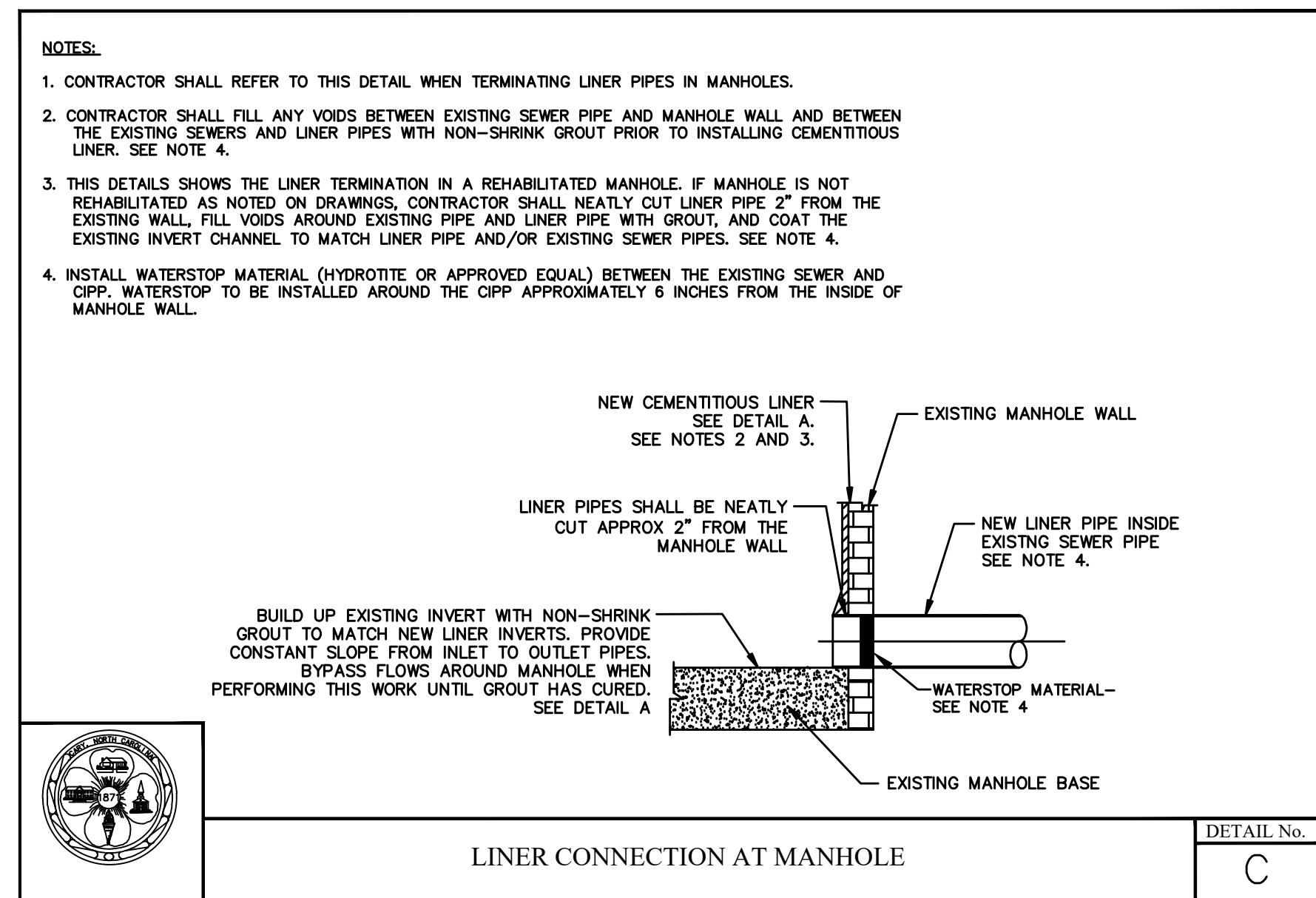
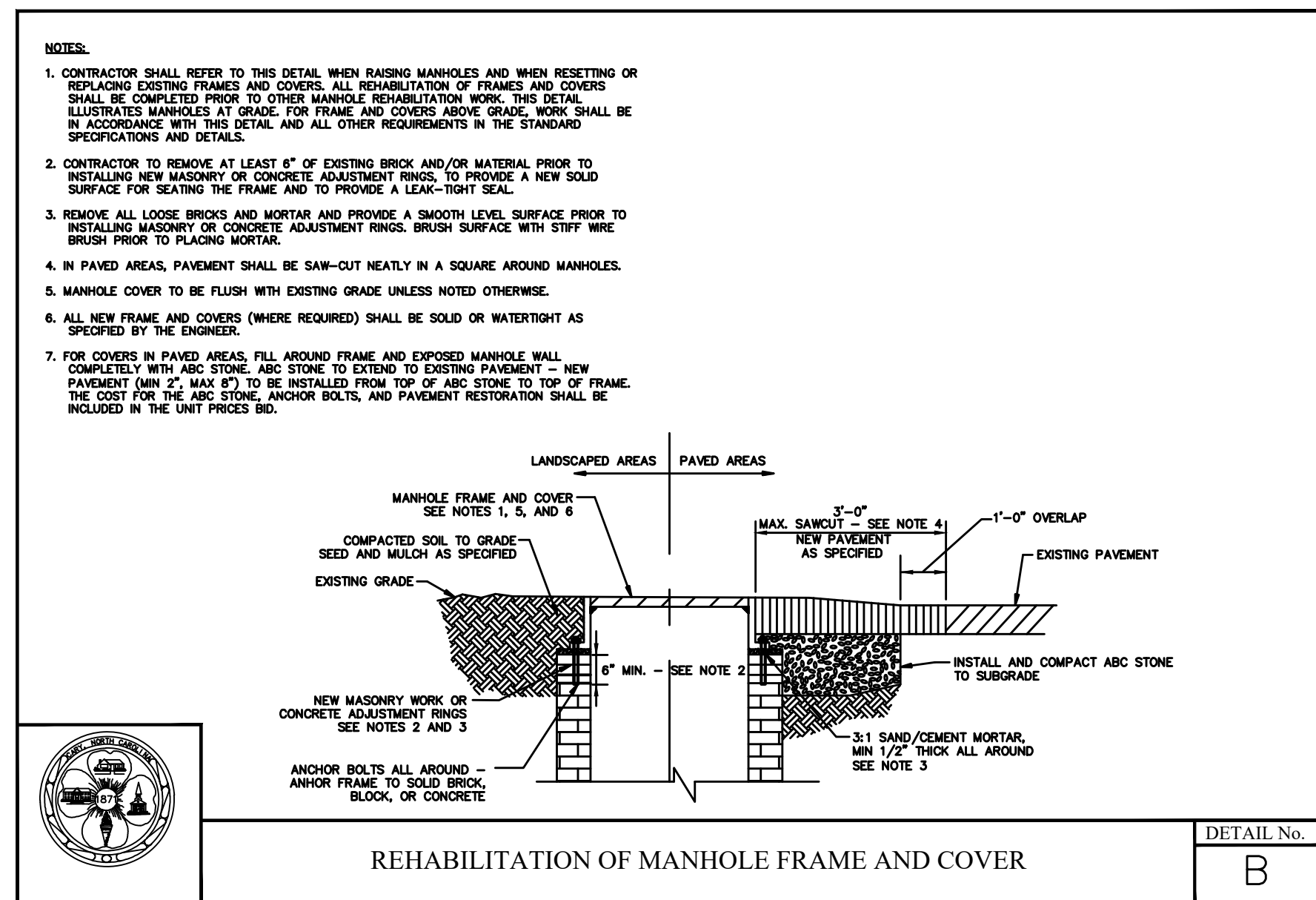
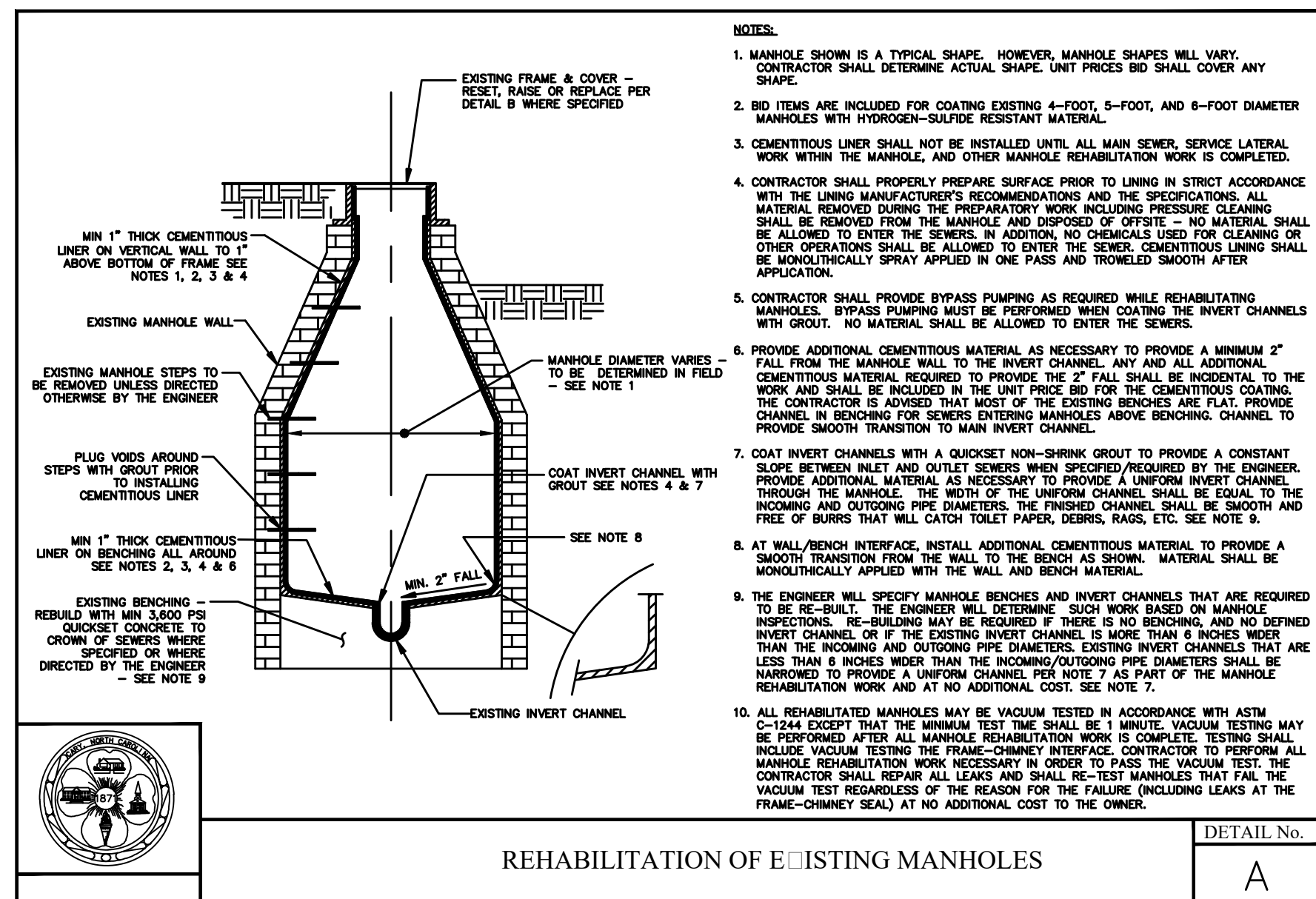

REVISIONS	CARY PROJECT No.: SW3501
	PROJECT No.: TOC-010
	DESIGNED BY:
	DRAWN BY: A. SPIROU
	CHECKED BY: M. COLANGELO
	APPROVED BY: M. LAMBERT
	DATE: MARCH 2021

TOWN OF CARY
CARY, NORTH CAROLINA

**FY 20-21 SEWER
REHABILITATION PROJECT**

DETAILS

SHEET No. **D-4**



Frazier Engineering, P.A.
6592 Bob White Trail
Stanley, NC 28164
Office 704.822.8444
Fax 704.822.8666

